



300W Single Output with PFC Function

HRP-300N series



■ Features

- Universal AC input / Full range
- Built-in active PFC function, PF>0.95
- 250% peak power capability
- High efficiency up to 89%
- Withstand 300VAC surge input for 5 seconds
- Protections: Short circuit / Overload / Over voltage / Over temperature
- 1U low profile 41mm
- Built-in cooling fan ON-OFF control
- Built-in DC OK signal
- Built-in remote sense function
- 5 years warranty

■ Applications

- Industrial automation machinery
- Industrial control system
- Mechanical and electrical equipment
- Diagnostic or biological facilities
- Test or measurement systems
- Telecommunication equipment

■ Description

HRP-300N is a 300W single output type AC/DC power supply. This series operates for 85~264VAC input voltage and offers the models with the DC output mostly demanded from the industry. Each model is cooled by the built-in fan with fan ON-OFF control, working for the temperature up to 70°C. Moreover, HRP-300N provides 250% short-duration peak power for motor applications and electromechanical loads requiring much higher power during start-up.

■ Model Encoding

HRP - 300N - 24

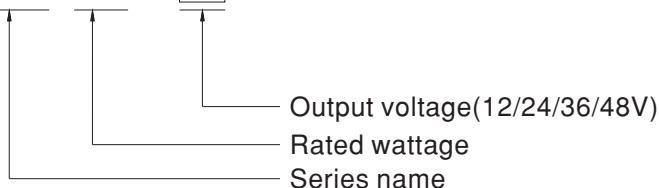



SPECIFICATION

| MODEL | | HRP-300N-12 | HRP-300N-24 | HRP-300N-36 | HRP-300N-48 | |
|--------------------------------|--|---|--|----------------|--|--|
| OUTPUT | DC VOLTAGE | 12V | 24V | 36V | 48V | |
| | RATED CURRENT | 27A | 14A | 9A | 7A | |
| | CURRENT RANGE | 0 ~ 27A | 0 ~ 14A | 0 ~ 9A | 0 ~ 7A | |
| | RATED POWER | 324W | 336W | 324W | 336W | |
| | RIPPLE & NOISE (max.) Note.2 | 120mVp-p | 150mVp-p | 250mVp-p | 250mVp-p | |
| | VOLTAGE ADJ. RANGE | 10.2 ~ 13.8V | 21.6 ~ 28.8V | 28.8 ~ 39.6V | 40.8 ~ 55.2V | |
| | VOLTAGE TOLERANCE Note.3 | ± 1.0% | ± 1.0% | ± 1.0% | ± 1.0% | |
| | LINE REGULATION | ± 0.3% | ± 0.2% | ± 0.2% | ± 0.2% | |
| | LOAD REGULATION | ± 0.5% | ± 0.5% | ± 0.5% | ± 0.5% | |
| | SETUP, RISE TIME | 1000ms, 50ms/230VAC 2500ms, 50ms/115VAC at full load | | | | |
| HOLD UP TIME (Typ.) | 16ms/230VAC 16ms/115VAC at full load | | | | | |
| INPUT | VOLTAGE RANGE Note.4 | 85 ~ 264VAC 120 ~ 370VDC | | | | |
| | FREQUENCY RANGE | 47 ~ 63Hz | | | | |
| | POWER FACTOR (Typ.) | PF>0.95/230VAC PF>0.99/115VAC at full load | | | | |
| | EFFICIENCY (Typ.) | 88% | 87% | 88% | 89% | |
| | AC CURRENT (Typ.) | 3.5A/115VAC 1.8A/230VAC | | | | |
| | INRUSH CURRENT (Typ.) | 35A/115VAC 75A/230VAC | | | | |
| | LEAKAGE CURRENT | <1.5mA / 240VAC | | | | |
| PROTECTION | OVERLOAD | Normally works within 105 ~ 200% rated output power for more than 5 seconds and then shut down o/p voltage, re-power on to recover Constant current limiting for output power >280% rated for more than 5 seconds and then shut down o/p voltage, re-power on to recover | | | | |
| | OVER VOLTAGE | 14.4 ~ 16.8V | 30 ~ 34.8V | 41.4 ~ 48.6V | 57.6 ~ 67.2V | |
| | OVER TEMPERATURE | Protection type : Shut down o/p voltage, re-power on to recover Shut down o/p voltage, recovers automatically after temperature goes down | | | | |
| FUNCTION | DC OK SIGNAL | PSU turns on : 3.3 ~ 5.6V ; PSU turns off : 0 ~ 1V | | | | |
| | FAN CONTROL (Typ.) | Load 35 ± 15% or RTH2 ≥ 50°C Fan on | | | | |
| ENVIRONMENT | WORKING TEMP. | -40 ~ +70°C (Refer to "Derating Curve") | | | | |
| | WORKING HUMIDITY | 20 ~ 90% RH non-condensing | | | | |
| | STORAGE TEMP., HUMIDITY | -40 ~ +85°C , 10 ~ 95% RH | | | | |
| | TEMP. COEFFICIENT | ± 0.03%/°C (0 ~ 50°C) | | | | |
| | VIBRATION | 10 ~ 500Hz, 5G 10min./1cycle, 60min. each along X, Y, Z axes | | | | |
| SAFETY & EMC (Note 5) | SAFETY STANDARDS | UL62368-1, TUV BS EN/EN62368-1, EAC TP TC 004, AS/NZS 62368.1 approved | | | | |
| | WITHSTAND VOLTAGE | I/P-O/P:3KVAC I/P-FG:2KVAC O/P-FG:0.5KVAC | | | | |
| | ISOLATION RESISTANCE | I/P-O/P, I/P-FG, O/P-FG:100M Ohms / 500VDC / 25°C / 70% RH | | | | |
| | EMC EMISSION | Parameter | Standard | | Test Level / Note | |
| | | Conducted | BS EN/EN55032 | | Class B | |
| | | Radiated | BS EN/EN55032 | | Class B | |
| | | Harmonic current | BS EN/EN61000-3-2 | | Class A | |
| | | Voltage Flicker | BS EN/EN61000-3-3 | | ----- | |
| | EMC IMMUNITY | BS EN/EN55035 , BS EN/EN61000-6-2(BS EN/EN50082-2) | | | | |
| | | Parameter | Standard | | Test Level / Note | |
| | | ESD | BS EN/EN61000-4-2 | | Level 3, 8KV air; Level 2, 4KV contact | |
| | | RF field | BS EN/EN61000-4-3 | | Level 3, 10V/m | |
| | | EFT/ Burst | BS EN/EN61000-4-4 | | Level 3, 2KV | |
| | | Surge | BS EN/EN61000-4-5 | | Level 4, 4KV/Line-FG; 2KV/Line-Line | |
| Conducted | | BS EN/EN61000-4-6 | | Level 3, 10V | | |
| Magnetic Field | | BS EN/EN61000-4-8 | | Level 4, 30A/m | | |
| Voltage Dips and Interruptions | BS EN/EN61000-4-11 | | 95% dip 0.5 periods, 30% dip 25 periods, 95% interruptions 250 periods | | | |
| OTHERS | MTBF | 529.1K hrs min. Telcordia TR/SR-332 (Bellcore) ; 201.43K hrs min. MIL-HDBK-217F (25°C) | | | | |
| | DIMENSION | 199*105*41mm (L*W*H) | | | | |
| | PACKING | 0.9Kg;15pcs/14.5Kg/0.84CUFT | | | | |
| NOTE | <p>1. All parameters NOT specially mentioned are measured at 230VAC input, rated load and 25°C of ambient temperature.</p> <p>2. Ripple & noise are measured at 20MHz of bandwidth by using a 12" twisted pair-wire terminated with a 0.1uf & 47uf parallel capacitor.</p> <p>3. Tolerance : includes set up tolerance, line regulation and load regulation.</p> <p>4. Derating may be needed under low input voltages. Please check the derating curve for more details.</p> <p>5. The power supply is considered a component which will be installed into a final equipment. All the EMC tests are been executed by mounting the unit on a 360mm*360mm metal plate with 1mm of thickness. The final equipment must be re-confirmed that it still meets EMC directives. For guidance on how to perform these EMC tests, please refer to "EMI testing of component power supplies." (as available on http://www.meanwell.com)</p> <p>6. The ambient temperature derating of 3.5°C/1000m with fanless models and of 5°C/1000m with fan models for operating altitude higher than 2000m(6500ft).</p> <p>※ Product Liability Disclaimer : For detailed information, please refer to https://www.meanwell.com/serviceDisclaimer.aspx</p> | | | | | |

Block Diagram

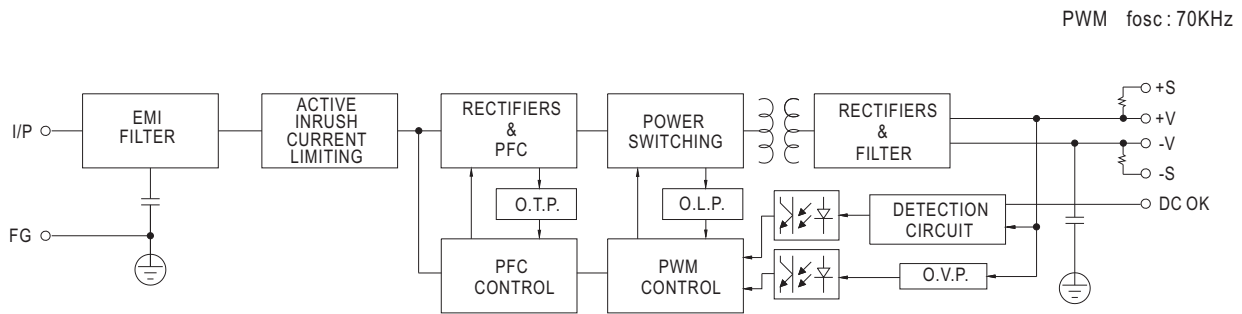

Derating Curve

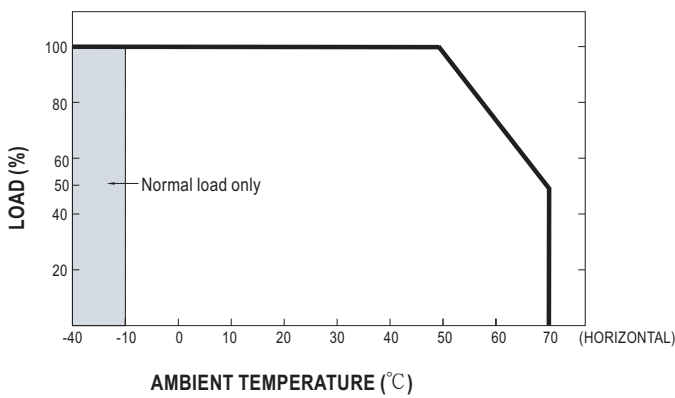

Output Derating VS Input Voltage

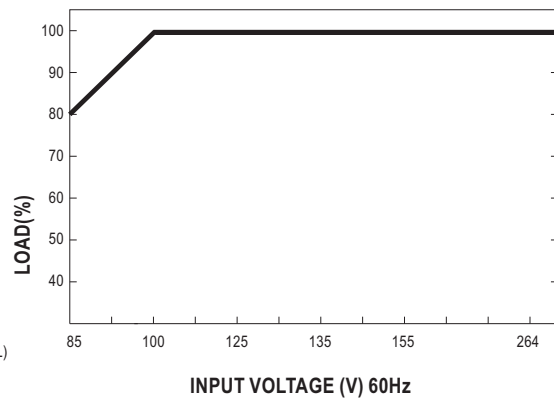

Function Manual

1. Remote Sense

The remote sensing compensates voltage drop on the load wiring up to 0.5V.

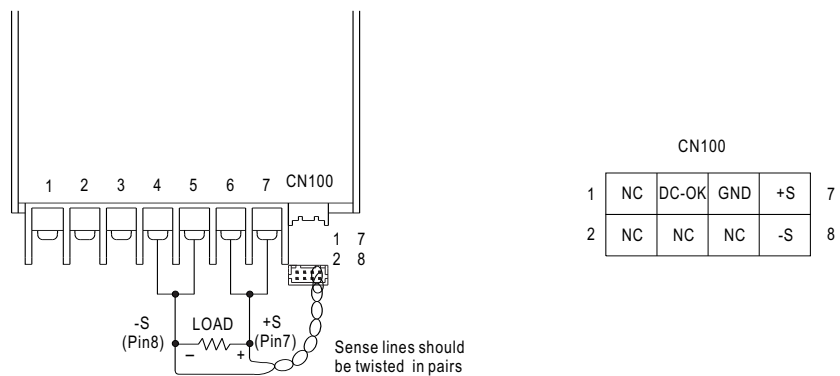
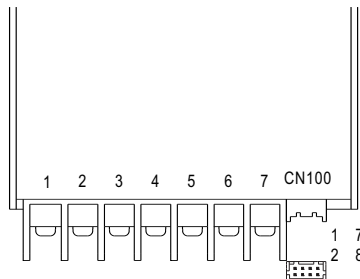

Fig 1.1

2.DC-OK Signal

DC-OK signal is a TTL level signal. High when PSU turns on.

| Between DC-OK(pin3) and GND(pin5) | Output Status |
|-----------------------------------|---------------|
| 3.3 ~ 5.6V | ON |
| 0 ~ 1V | OFF |



| CN100 | | | | | |
|-------|----|-------|-----|----|---|
| 1 | NC | DC-OK | GND | +S | 7 |
| 2 | NC | NC | NC | -S | 8 |

Fig 2.1

3.Peak Power

$$P_{av} = \frac{P_{pk} \times t + P_{npk} \times (T-t)}{T} \leq P_{rated}$$

$$\text{Duty} \frac{t}{T} \times 100\% \leq 35\%$$

$$t \leq 5 \text{ sec}$$

P_{av} : Average output power (W)

P_{pk} : Peak output power (W)

P_{npk} : Non-peak output power (W)

P_{rated} : Rated output power (W)

t : Peak power width (sec)

T : Period (sec)

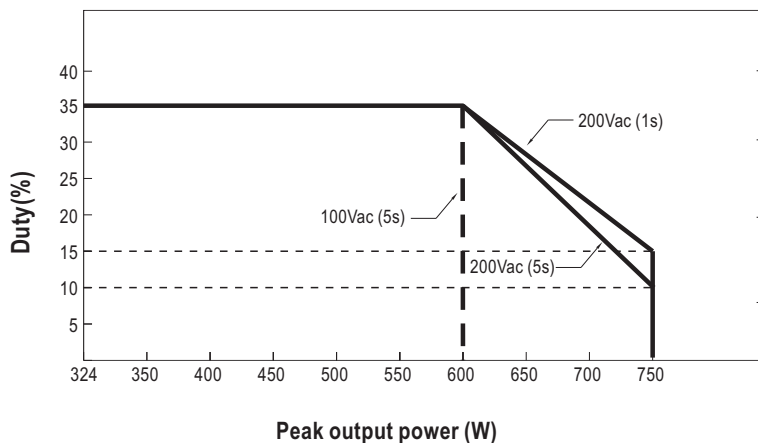
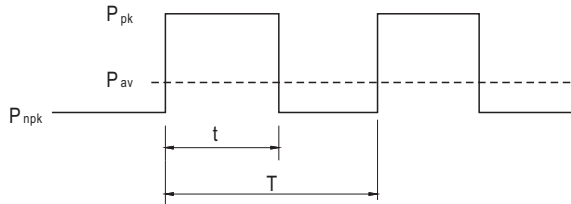

For example (12V model) :

$V_{in} = 100V$ $\text{Duty}_{max} = 35\%$

$P_{av} = P_{rated} = 324W$

$P_{pk} = 600W$

$t \leq 5 \text{ sec}$

$T \geq 14.29 \text{ sec}$

$$P_{av} = \frac{P_{pk} \times t + P_{npk} \times (T-t)}{T} = \frac{600 \times 5 + P_{npk} \times (14.29-5)}{14.29} \leq 324W$$

$$P_{npk} \leq 175.4W$$

Mechanical Specification

Case No.980A Unit:mm

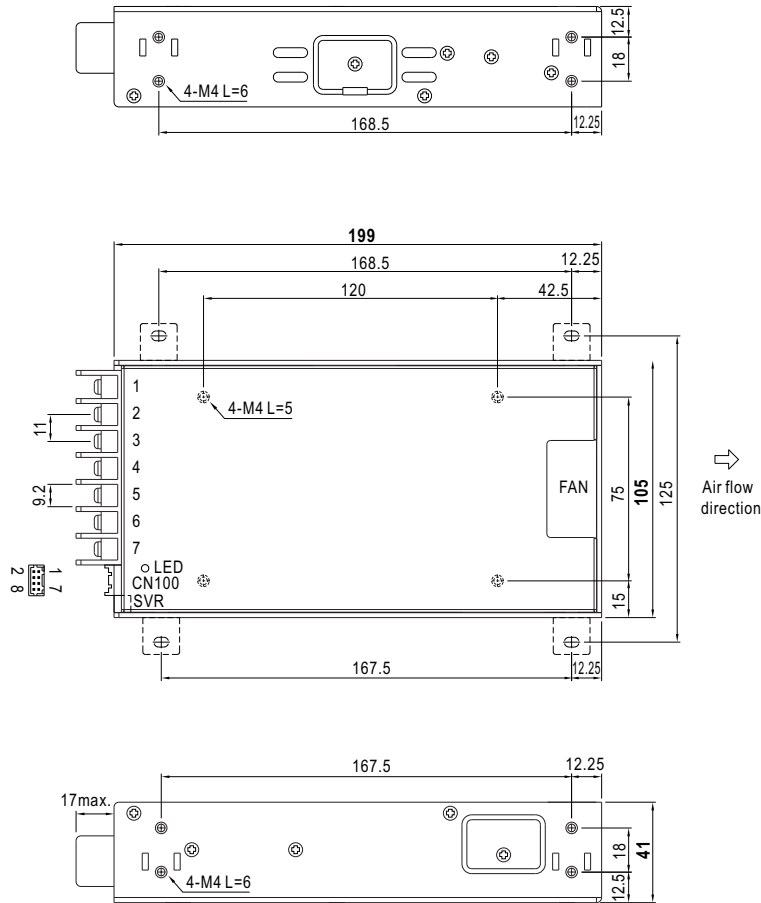

Terminal Pin No. Assignment

| Pin No. | Assignment | Pin No. | Assignment |
|---------|------------|---------|--------------|
| 1 | AC/L | 4,5 | DC OUTPUT -V |
| 2 | AC/N | 6,7 | DC OUTPUT +V |
| 3 | FG \perp | | |

Connector Pin No. Assignment (CN100) :
HRS DF11-08DP-2DS or equivalent

| Pin No. | Assignment | Mating Housing | Terminal |
|---------|------------|----------------------------|-----------------------------|
| 1,2,4,6 | NC | HRS DF11-8DS or equivalent | HRS DF11-**SC or equivalent |
| 3 | DC-OK | | |
| 5 | GND | | |
| 7 | +S | | |
| 8 | -S | | |

Installation Manual

Please refer to : <http://www.meanwell.com/manual.html>