



■ Features :

- 1U low profile
- 19-inch rack mounting
- Control and monitor up to 3 RCP-1000 units
- Suitable for all kinds of RCP output (12V,24V,48V)
- Digital meters for output voltage, output current, and internal temperature on front panel
- Potential meter for adjusting output voltage of RCP-1000 unit on front panel
- Relay contacts and LED indicators for AC fail, DC fail, and over temperature warning
- Removable fixing accessory
- 3 years warranty

■ Description : RCP-MU is the monitoring and control unit used for the RCP-1000 series rack power. It can decode the I²C signal sent by RCP series and display through digital meters or relay contact signals. RCP-MU can also turn ON/OFF or trim the output voltage of RCP-1000 remotely that make the basic control more easily.

■ GTIN CODE

MW Search: <https://www.meanwell.com/serviceGTIN.aspx>



SPECIFICATION

MODEL	RCP-MU	
INPUT	VOLTAGE RANGE	90 ~ 264VAC 127 ~ 370VDC
	FREQUENCY RANGE	47 ~ 63Hz
	AC CURRENT (Typ.)	0.35A/115VAC 0.2A/230VAC
	INRUSH CURRENT (Typ.)	30A/115VAC 50A/230VAC
	MONITORING INPUTS	I ² C signal (AC OK, DC OK, and over temperature alarm signals for each RCP-1000 unit), output voltage of the RCP-1U rack
OUTPUT	DIGITAL METER <small>Note.2</small>	Display the DC output voltage, current, and internal temperature of each RCP-1000 unit
	CONTROL OUTPUT	Remote ON/OFF and output voltage trimming for each RCP-1000 unit
	RELAY CONTACT	Alarm for AC Fail, DC Fail, and Over Temperature ; rating : 30VDC, 1A
	LED INDICATOR	AC Fail, DC Fail, Over Temperature
FUNCTION	REMOTE ON/OFF CONTROL	The controlled RCP-1000 unit can be turned ON/OFF on the front panel for RCP-MU
	VOLTAGE TRIM	Output voltage of the controlled RCP-1000 unit and be trimmed by ±10% on the front panel of RCP-MU
ENVIRONMENT	WORKING TEMP.	-20 ~ +60°C
	WORKING HUMIDITY	20~90% RH non-condensing
	STORAGE TEMP., HUMIDITY	-40 ~ +85°C, 10 ~ 95% RH non-condensing
	VIBRATION	10 ~ 500Hz, 2G 10min./1cycle, 60min. each along X, Y, Z axes
SAFETY & EMC	SAFETY STANDARDS	Design refer to EN62368-1, EAC TP TC 004 approved
	WITHSTAND VOLTAGE	I/P-O/P:3KVAC I/P-FG:1.5KVAC O/P-FG:0.5KVAC
	ISOLATION RESISTANCE	I/P-O/P, I/P-FG, O/P-FG:100M Ohms / 500VDC / 25°C / 70% RH
	EMC EMISSION	Compliance to EN55032 (CISPR32) Class B, EN61000-3-2,-3, EAC TP TC 020
	EMC IMMUNITY	Compliance to EN61000-4-2,3,4,5,6,8,11, EN55035, EAC TP TC 020
OTHERS	MTBF	346.7K hrs min. Telcordia SR-332 (Bellcore) ; 255.4K hrs min. MIL-HDBK-217F (25°C)
	DIMENSION	440*68*44mm (L*W*H)
	PACKING	1.15Kg; 6pcs/8Kg/1.27CUFT
NOTE	1. All parameters NOT specially mentioned are measured at 230VAC input, rated load and 25°C of ambient temperature. 2. Resolution and tolerance of the values shown on the digital meter depends on the controlled RCP series. 3. The ambient temperature derating of 3.5°C/1000m with fanless models and of 5°C/1000m with fan models for operating altitude higher than 2000m(6500ft). ※ Product Liability Disclaimer : For detailed information, please refer to https://www.meanwell.com/serviceDisclaimer.aspx	

Mechanical Specification

(Unit: mm , tolerance ± 1 mm)

Case No. 701A

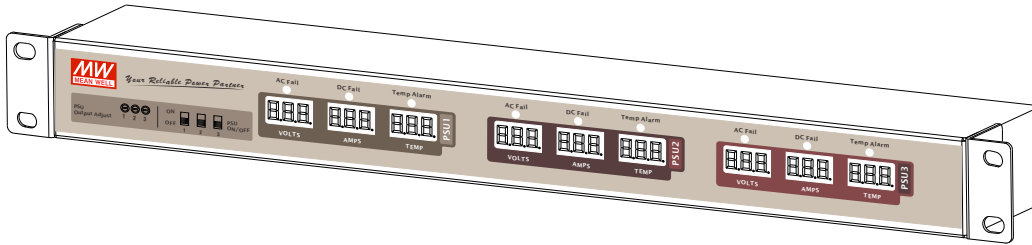

BACK

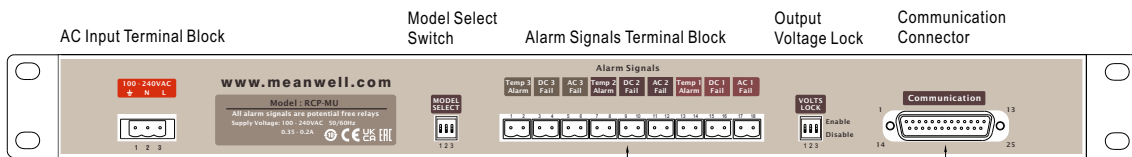

AC Input Terminal Block

Pin No.	Assignment
1	FG \perp
2	AC/N
3	AC/L

Alarm Signals Pin No. Assignment

Pin No.	Assignment	Pin No.	Assignment	Pin No.	Assignment
1,2	Temp 3 Fail	7,8	Temp 2 Fail	13,14	Temp 1 Fail
3,4	DC 3 Fail	9,10	DC 2 Fail	15,16	DC 1 Fail
5,6	AC 3 Fail	11,12	AC 2 Fail	17,18	AC 1 Fail

Communication Connector Pin No. Assignment

Pin No.	Assignment	Pin No.	Assignment	Pin No.	Assignment	Pin No.	Assignment	Pin No.	Assignment
1	ON/OFF-A	6	+5V-AUX	11	V-TRIM-B	16	AC-OK-C	21	-S
2	AC-OK-A	7	GND-AUX	12	T-ALARM-B	17	DC-OK-C	22	+V
3	DC-OK-A	8	ON/OFF-B	13	NC	18	V-TRIM-C	23	SCL
4	V-TRIM-A	9	AC-OK-B	14	CS	19	T-ALARM-C	24	SDA
5	T-ALARM-A	10	DC-OK-B	15	ON/OFF-C	20	+S	25	-V

TOP

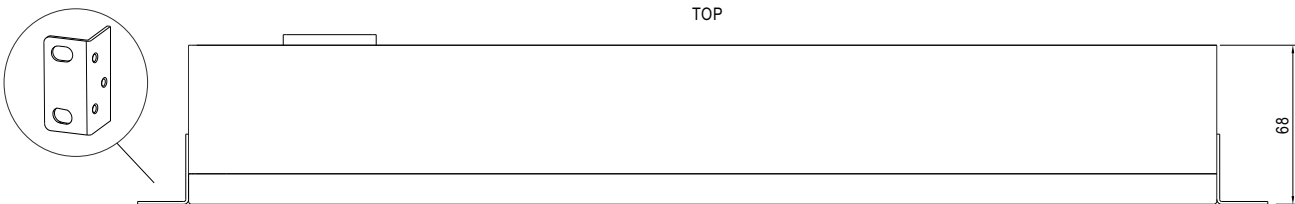

FRONT

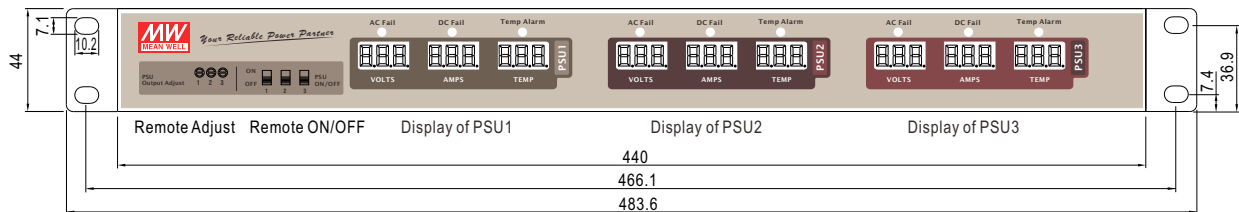

Block Diagram

The diagram below only shows one set of input / output signals. One RCP-MU can control and monitor up to 3 units of RCP-1000 power unit.

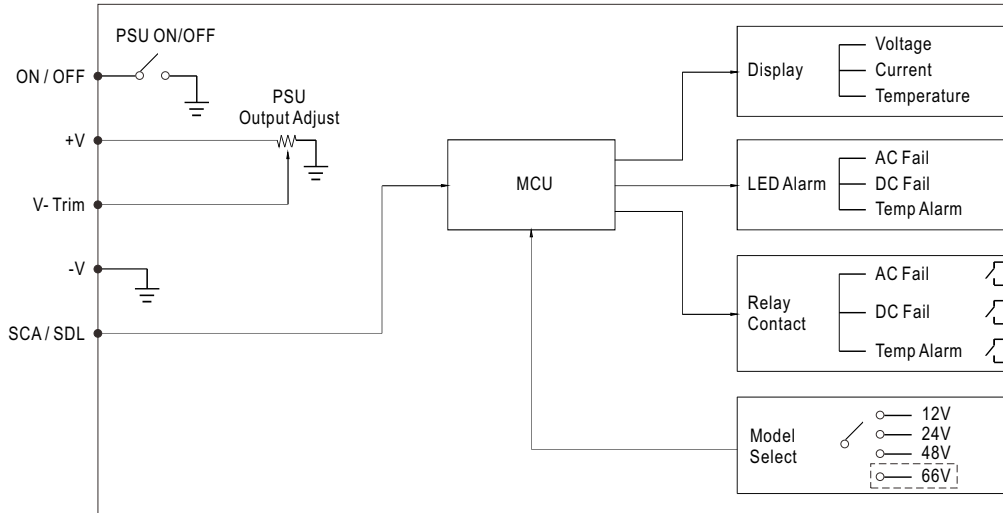

Typical User Manual

1. Monitoring Input

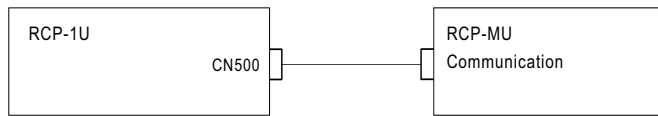

RCP-1U Address dip switch setting

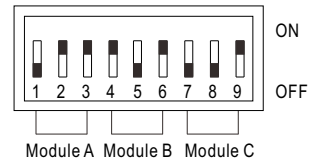

2. Alarm Signal Relay Contact

Function	Description
AC Fail	When input AC fail, relay open, LED lights
DC Fail	When output DC fail, relay open, LED lights
Temp Alarm	When temperature exceed the limit of temperature, relay open, LED lights

3. Model Select Switch

To get better display resolution, the correct output voltage of RCP-1000 that is monitored should be chosen. The factory original setting is for 48V models.

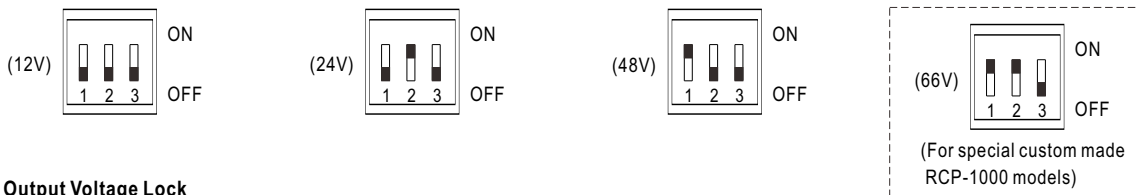

4. Output Voltage Lock

The output voltage adjustment for RCP-1000 units can be enabled or disabled for different application needs.

