



Наличие и актуальные цены на

**ELG-150-24B-3Y**

<https://www.mean-well.ru/store/ELG-150-24B-3Y/>



# 84~150W Constant Voltage + Constant Current LED Driver **ELG-150** series



IS 15885(Part 2/Sec13)  
R-41027766  
(Please refer safety description)



## ■ Features

- Constant Voltage + Constant Current mode output
- Metal housing design with functional Ground
- Built-in active PFC function
- No load / Standby power consumption <0.5W
- IP67 / IP65 rating for indoor or outdoor installations
- Function options: output adjustable via potentiometer; 3 in 1 dimming (dim-to-off); Smart timer dimming; DALI
- Typical lifetime>50000 hours
- 5 years warranty

## ■ Applications

- LED street lighting
- LED architectural lighting
- LED bay lighting
- LED floodlighting
- Type "HL" for use in Class I, Division 2 hazardous (Classified) location.

## ■ GTIN CODE

MW Search: <https://www.meanwell.com/serviceGTIN.aspx>

## ■ Description

ELG-150 series is a 150W AC/DC LED driver featuring the dual mode constant voltage and constant current output. ELG-150 operates from 100~305VAC and offers models with different rated voltage ranging between 12V and 54V. Thanks to the high efficiency up to 91%, with the fanless design, the entire series is able to operate for -40°C ~ +90°C case temperature under free air convection. The design of metal housing and IP67/IP65 ingress protection level allows this series to fit both indoor and outdoor applications. ELG-150 is equipped with various function options, such as dimming methodologies, so as to provide the optimal design flexibility for LED lighting system

## ■ Model Encoding

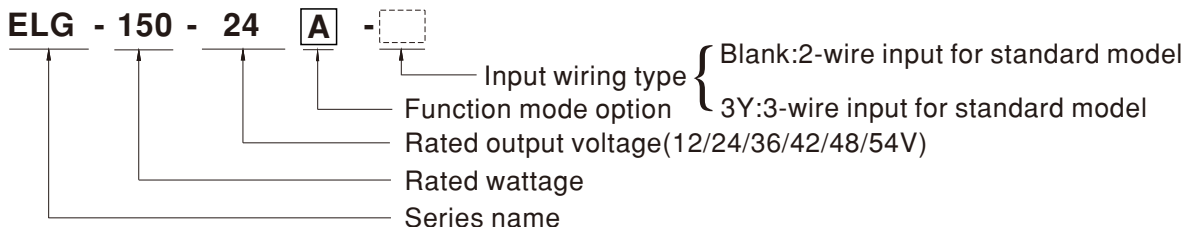

| Type  | IP Level | Function   | Note       |
|-------|----------|--|------------|
| Blank | IP67     | Io and Vo fixed.   | In Stock   |
| A     | IP65     | Io and Vo adjustable through built-in potentiometer.   | In Stock   |
| B     | IP67     | 3 in 1 dimming function (0~10Vdc, 10V PWM signal and resistance)   | In Stock   |
| AB    | IP65     | Io and Vo adjustable through built-in potentiometer & 3 in 1 dimming function (0~10Vdc, 10V PWM signal and resistance) | In Stock   |
| DA    | IP67     | DALI control technology.   | In Stock   |
| Dx    | IP67     | Built-in Smart timer dimming function by user request.   | By request |
| D2    | IP67     | Built-in Smart timer dimming and programmable function.  | In Stock   |

**SPECIFICATION**

| MODEL                   | ELG-150-12□  | ELG-150-24□   | ELG-150-36□  | ELG-150-42□  | ELG-150-48□  | ELG-150-54□  |            |
|-------------------------|--|---|--------------|--------------|--------------|--------------|------------|
| OUTPUT                  | DC VOLTAGE   | 12V   | 24V          | 36V          | 42V          | 48V          | 54V        |
|                         | CONSTANT CURRENT REGION Note.2   | 6 ~ 12V   | 12 ~ 24V     | 18 ~ 36V     | 21 ~ 42V     | 24 ~ 48V     | 27 ~ 54V   |
|                         | RATED CURRENT  | 10A   | 6.25A        | 4.17A        | 3.57A        | 3.13A        | 2.8A       |
|                         | RATED POWER  | 100VAC ~ 180VAC   |              |              |              |              |            |
|                         |  | 84W   | 105W         | 105W         | 105W         | 105W         | 105W       |
|                         |  | 200VAC ~ 305VAC   |              |              |              |              |            |
|                         |  | 120W  | 150W         | 150.1W       | 150W         | 150.2W       | 151.2W     |
|                         | RIPPLE & NOISE (max.) Note.3   | 150mVp-p  | 200mVp-p     | 250mVp-p     | 250mVp-p     | 250mVp-p     | 350mVp-p   |
|                         | VOLTAGE ADJ. RANGE   | Adjustable for A/AB-Type only (via the built-in potentiometer)  |              |              |              |              |            |
|                         |  | 10.8 ~ 13.2V  | 21.6 ~ 26.4V | 32.4 ~ 39.6V | 37.8 ~ 46.2V | 43.2 ~ 52.8V | 49 ~ 58V   |
|                         | CURRENT ADJ. RANGE   | Adjustable for A/AB-Type only (via the built-in potentiometer)  |              |              |              |              |            |
|                         |  | 5 ~ 10A   | 3.2 ~ 6.25A  | 2.1 ~ 4.17A  | 1.8 ~ 3.57A  | 1.56 ~ 3.13A | 1.4 ~ 2.8A |
|                         | VOLTAGE TOLERANCE Note.4   | ±3.0%   | ±3.0%        | ±2.5%        | ±2.5%        | ±2.0%        | ±2.0%      |
|                         | LINE REGULATION  | ±0.5%   | ±0.5%        | ±0.5%        | ±0.5%        | ±0.5%        | ±0.5%      |
| LOAD REGULATION         | ±2.0%  | ±1.0%   | ±1.0%        | ±0.5%        | ±0.5%        | ±0.5%        |            |
| SETUP, RISE TIME Note.6 | 1600ms, 80ms/115VAC 500ms, 100ms/230VAC  |   |              |              |              |              |            |
| HOLD UP TIME (Typ.)     | 10ms/115VAC, 230VAC  |   |              |              |              |              |            |
| INPUT                   | VOLTAGE RANGE Note.5   | 100 ~ 305VAC 142 ~ 431VDC<br>(Please refer to "STATIC CHARACTERISTIC" section)  |              |              |              |              |            |
|                         | FREQUENCY RANGE  | 47 ~ 63Hz   |              |              |              |              |            |
|                         | POWER FACTOR   | PF ≥ 0.97/115VAC, PF ≥ 0.95/230VAC, PF ≥ 0.92/277VAC@full load<br>(Please refer to "POWER FACTOR (PF) CHARACTERISTIC" section)  |              |              |              |              |            |
|                         | TOTAL HARMONIC DISTORTION  | THD < 20% (@load ≥ 50%/115VAC; @load ≥ 60%/230VAC; @load ≥ 75%/277VAC)<br>(Please refer to "TOTAL HARMONIC DISTORTION (THD)" section)   |              |              |              |              |            |
|                         | EFFICIENCY (Typ.)  | 88.5%   | 89%          | 90%          | 90%          | 90%          | 91%        |
|                         | AC CURRENT   | 1.7A / 115VAC 0.9A / 230VAC 0.7A/277VAC   |              |              |              |              |            |
|                         | INRUSH CURRENT(Typ.)   | COLD START 65A(twidth=550μs measured at 50% Ipeak) at 230VAC; Per NEMA 410  |              |              |              |              |            |
|                         | MAX. No. of PSUs on 16A CIRCUIT BREAKER  | 3 units (circuit breaker of type B) / 6 units (circuit breaker of type C) at 230VAC   |              |              |              |              |            |
|                         | LEAKAGE CURRENT  | <0.75mA / 277VAC  |              |              |              |              |            |
|                         | NO LOAD / STANDBY POWER CONSUMPTION  | No load power consumption <0.5W for Blank / A / Dx / D2-Type<br>Standby power consumption <0.5W for B / AB / DA-Type  |              |              |              |              |            |
| PROTECTION              | OVER CURRENT   | 95 ~ 108%<br>Constant current limiting, recovers automatically after fault condition is removed   |              |              |              |              |            |
|                         | SHORT CIRCUIT  | Hiccup mode, recovers automatically after fault condition is removed  |              |              |              |              |            |
|                         | OVER VOLTAGE   | 14 ~ 18V  | 28 ~ 34V     | 41 ~ 48V     | 47 ~ 54V     | 54 ~ 62V     | 59 ~ 68V   |
|                         |  | Shut down output voltage, re-power on to recover  |              |              |              |              |            |
| OVER TEMPERATURE        | Shut down output voltage, re-power on to recover   |   |              |              |              |              |            |
| ENVIRONMENT             | WORKING TEMP.  | Tcase=-40 ~ +90°C (Please refer to " OUTPUT LOAD vs TEMPERATURE" section)   |              |              |              |              |            |
|                         | MAX. CASE TEMP.  | Tcase=+90°C   |              |              |              |              |            |
|                         | WORKING HUMIDITY   | 20 ~ 95% RH non-condensing  |              |              |              |              |            |
|                         | STORAGE TEMP., HUMIDITY  | -40 ~ +80°C, 10 ~ 95% RH  |              |              |              |              |            |
|                         | TEMP. COEFFICIENT  | ±0.03%/°C (0 ~ 60°C)  |              |              |              |              |            |
|                         | VIBRATION  | 10 ~ 500Hz, 5G 12min./1cycle, period for 72min. each along X, Y, Z axes   |              |              |              |              |            |
| SAFETY & EMC            | SAFETY STANDARDS   | UL8750(type"HL"), CSA C22.2 No. 250.13-12;IEC/BS EN/EN/AS/NZS 61347-1,IEC/BS EN/EN/AS/NZS 61347-2-13 independent,BS EN/EN62384,BIS IS15885(for 12/12A/12B/12DA/24/24A/24B/24DA/36A/36B/42/42A/42B/48A/48B/54/54A/54B only), EAC TP TC 004,GB19510.1,GB19510.14; IP65 or IP67; KC61347-1.KC61347-2-13 approved |              |              |              |              |            |
|                         | DALI STANDARDS   | Compliance to IEC62386-101,102,(207 by request) for DA Type only  |              |              |              |              |            |
|                         | WITHSTAND VOLTAGE  | I/P-O/P:3.75KVAC I/P-FG:2.0KVAC O/P-FG:1.5KVAC  |              |              |              |              |            |
|                         | ISOLATION RESISTANCE   | I/P-O/P, I/P-FG, O/P-FG:100M Ohms / 500VDC / 25°C / 70% RH  |              |              |              |              |            |
|                         | EMC EMISSION   | Compliance to BS EN/EN55015,BS EN/EN61000-3-2 Class C (@load ≥ 60%); BS EN/EN61000-3-3; GB/T 17743,GB17625.1, EAC TP TC 020; KC KN15,KN61547  |              |              |              |              |            |
|                         | EMC IMMUNITY   | Compliance to BS EN/EN61000-4-2,3,4,5,6,8,11; BS EN/EN61547, light industry level (surge immunity Line-Earth 6KV, Line-Line 4KV),EAC TP TC 020; KC KN15,KN61547   |              |              |              |              |            |
| OTHERS                  | MTBF   | 2661.6K hrs min. Telcordia SR-332 (Bellcore); 313.7K hrs min. MIL-HDBK-217F (25°C)  |              |              |              |              |            |
|                         | DIMENSION  | 219*63*35.5mm (L*W*H)   |              |              |              |              |            |
|                         | PACKING  | 0.95Kg; 16pcs/16.0kg/0.77CUFT   |              |              |              |              |            |
| NOTE                    | <p>1. All parameters NOT specially mentioned are measured at 230VAC input, rated current and 25°C of ambient temperature.</p> <p>2. Please refer to "DRIVING METHODS OF LED MODULE". For DA-Type, Constant Current region is 60%~100% of maximum voltage under rated power delivery.</p> <p>3. Ripple &amp; noise are measured at 20MHz of bandwidth by using a 12" twisted pair-wire terminated with a 0.1uf &amp; 47uf parallel capacitor.</p> <p>4. Tolerance : includes set up tolerance, line regulation and load regulation.</p> <p>5. De-rating may be needed under low input voltages. Please refer to "STATIC CHARACTERISTICS" sections for details.</p> <p>6. Length of set up time is measured at first cold start. Turning ON/OFF the driver may lead to increase of the set up time.</p> <p>7. The driver is considered as a component that will be operated in combination with final equipment. Since EMC performance will be affected by the complete installation, the final equipment manufacturers must re-qualify EMC Directive on the complete installation again.<br/>(as available on <a href="https://www.meanwell.com/Upload/PDF/EMI_statement_en.pdf">https://www.meanwell.com/Upload/PDF/EMI_statement_en.pdf</a>)</p> <p>8. This series meets the typical life expectancy of &gt;50,000 hours of operation when Tcase, particularly (Tc) point (or TMP, per DLC), is about 80°C or less.</p> <p>9. Please refer to the warranty statement on MEAN WELL's website at <a href="http://www.meanwell.com">http://www.meanwell.com</a>.</p> <p>10. The ambient temperature derating of 3.5°C/1000m with fanless models and of 5°C/1000m with fan models for operating altitude higher than 2000m(6500ft).</p> <p>11. For any application note and IP water proof function installation caution, please refer our user manual before using.<br/><a href="https://www.meanwell.com/Upload/PDF/LED_EN.pdf">https://www.meanwell.com/Upload/PDF/LED_EN.pdf</a></p> <p>12. To fulfill requirements of the latest ErP regulation for lighting fixtures, this LED power supply can only be used behind a switch without permanently connected to the mains.</p> <p>13. ELG-150-12(except blank/A-Type) is used for any light source that exempt from the ErP-Directive (EU) 2019/2020 requirement, for example this model could be use for signalling products(including, but not limited to road-, railway-, marineorair traffic-signalling , traffic control or airfield lamps) .</p> <p>14. For A/AB type need to consider build in using to comply with Type HL application.</p> <p>※ Product Liability Disclaimer : For detailed information, please refer to <a href="https://www.meanwell.com/serviceDisclaimer.aspx">https://www.meanwell.com/serviceDisclaimer.aspx</a></p> |   |              |              |              |              |            |

## ■ Block Diagram

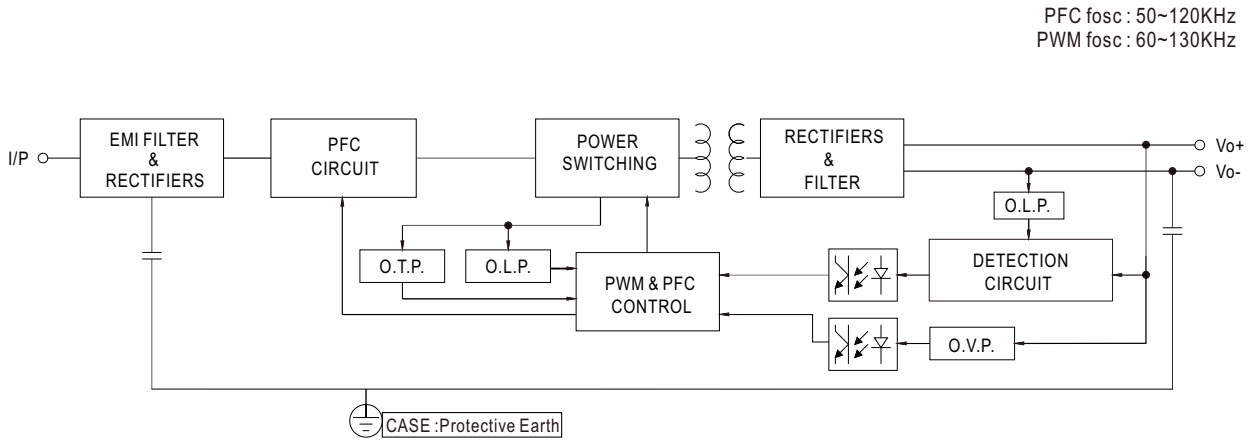

## ■ DRIVING METHODS OF LED MODULE

※ This series is able to work in either Constant Current mode (a direct drive way) or Constant Voltage mode (usually through additional DC/DC driver) to drive the LEDs.

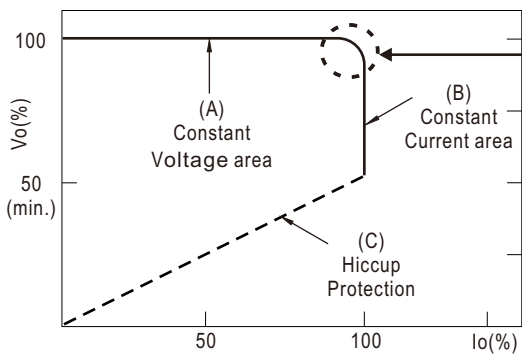

Typical output current normalized by rated current (%)

In the constant current region, the highest voltage at the output of the driver depends on the configuration of the end systems.

Should there be any compatibility issues, please contact MEAN WELL.

© This characteristic applies to Blank/A/B/AB/DX/D2-Type,  
For DA-Type, the Constant Current area is 60%~100% Vo.

## ■ DIMMING OPERATION

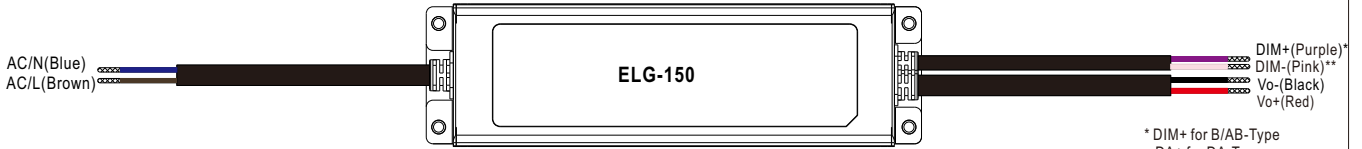

### ※ 3 in 1 dimming function (for B/AB-Type)

- Output constant current level can be adjusted by applying one of the three methodologies between DIM+ and DIM-: 0 ~ 10VDC, or 10V PWM signal or resistance.
- Direct connecting to LEDs is suggested. It is not suitable to be used with additional drivers.
- Dimming source current from power supply: 100 $\mu$ A (typ.)

\* DIM+ for B/AB-Type  
DA+ for DA-Type  
PROG+ for D2-Type  
\* DIM- for B/AB-Type  
DA- for DA-Type  
PROG- for D2-Type

#### ◎ Applying additive 0 ~ 10VDC

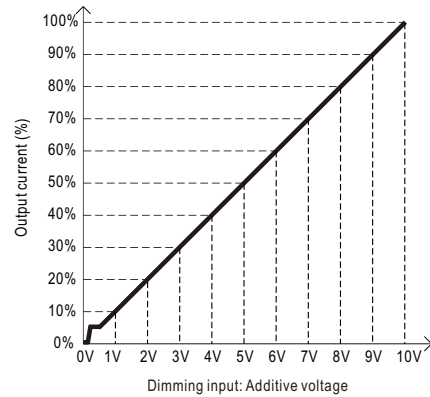
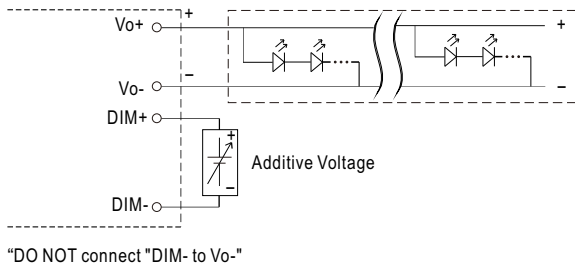

#### ◎ Applying additive 10V PWM signal (frequency range 100Hz ~ 3KHz):

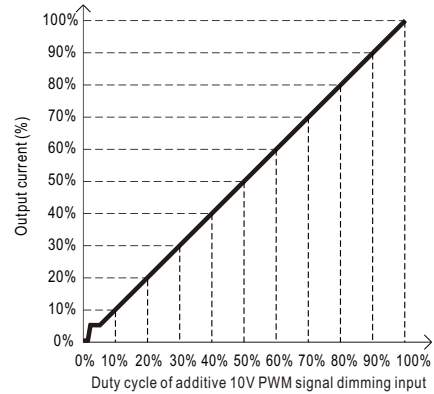
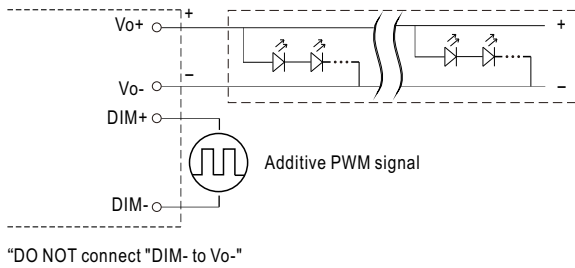

#### ◎ Applying additive resistance:

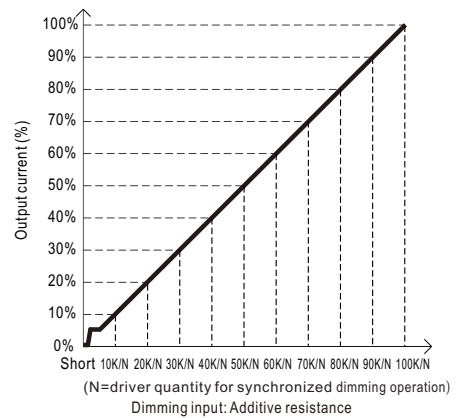
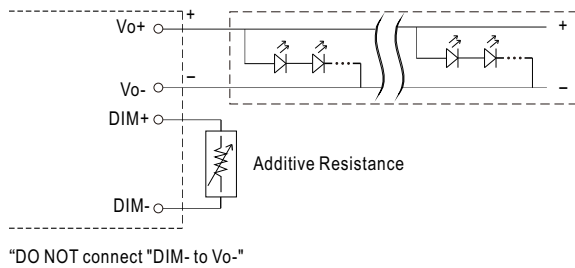

Note : 1. Min. dimming level is about 8% and the output current is not defined when  $0\% < I_{out} < 8\%$ .  
2. The output current could drop down to 0% when dimming input is about 0k $\Omega$  or 0Vdc, or 10V PWM signal with 0% duty cycle.

※ **DALI Interface (primary side; for DA-Type)**

- Apply DALI signal between DA+ and DA-.
- DALI protocol comprises 16 groups and 64 addresses.
- First step is fixed at 8% of output.

※ **Smart timer dimming function (for Dxx-Type by User definition)**

MEAN WELL Smart timer dimming primarily provides the adaptive proportion dimming profile for the output constant current level to perform up to 14 consecutive hours. 3 dimming profiles hereunder are defined accounting for the most frequently seen applications. If other options may be needed, please contact MEAN WELL for details.

Ex : ☉ D01-Type: the profile recommended for residential lighting

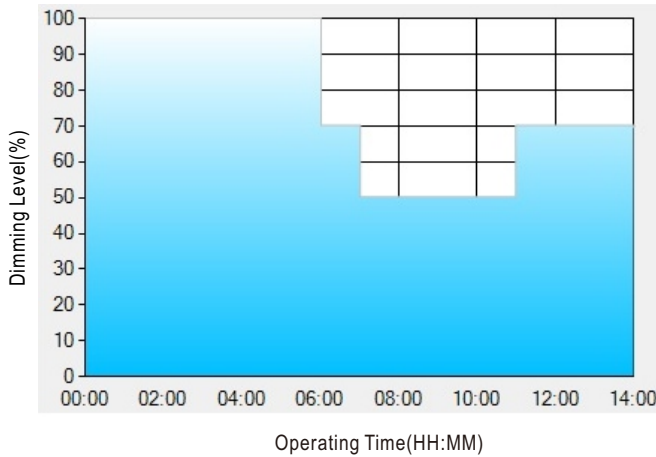

Set up for D01-Type in Smart timer dimming software program:

|         | T1    | T2    | T3    | T4  |
|---------|-------|-------|-------|-----|
| TIME**  | 06:00 | 07:00 | 11:00 | --- |
| LEVEL** | 100%  | 70%   | 50%   | 70% |

\*\* : TIME matches Operating Time in the diagram whereas LEVEL matches Dimming Level.

Example: If a residential lighting application adopts D01-Type, when turning on the power supply at 6:00pm, for instance:

- [1] The power supply will switch to the constant current level at 100% starting from 6:00pm.
- [2] The power supply will switch to the constant current level at 70% in turn, starting from 0:00am, which is 06:00 after the power supply turns on.
- [3] The power supply will switch to the constant current level at 50% in turn, starting from 1:00am, which is 07:00 after the power supply turns on.
- [4] The power supply will switch to the constant current level at 70% in turn, starting from 5:00am, which is 11:00 after the power supply turns on.

The constant current level remains till 8:00am, which is 14:00 after the power supply turns on.

Ex : ☉ D02-Type: the profile recommended for street lighting

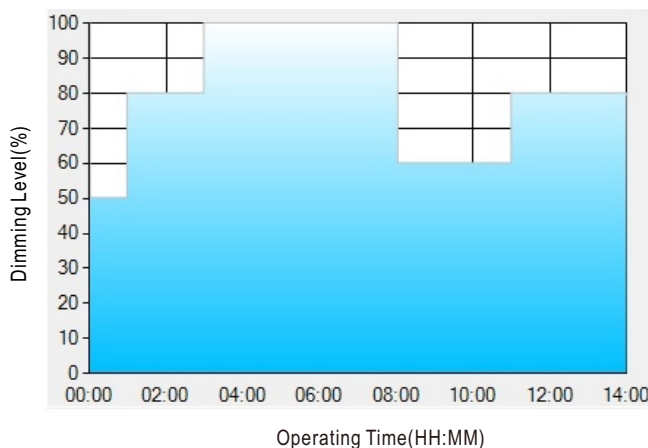

Set up for D02-Type in Smart timer dimming software program:

|         | T1    | T2    | T3   | T4    | T5  |
|---------|-------|-------|------|-------|-----|
| TIME**  | 01:00 | 03:00 | 8:00 | 11:00 | --- |
| LEVEL** | 50%   | 80%   | 100% | 60%   | 80% |

\*\* : TIME matches Operating Time in the diagram whereas LEVEL matches Dimming Level.

Example: If a street lighting application adopts D02-Type, when turning on the power supply at 5:00pm, for instance:

- [1] The power supply will switch to the constant current level at 50% starting from 5:00pm.
- [2] The power supply will switch to the constant current level at 80% in turn, starting from 6:00pm, which is 01:00 after the power supply turns on.
- [3] The power supply will switch to the constant current level at 100% in turn, starting from 8:00pm, which is 03:00 after the power supply turns on.
- [4] The power supply will switch to the constant current level at 60% in turn, starting from 1:00am, which is 08:00 after the power supply turns on.
- [5] The power supply will switch to the constant current level at 80% in turn, starting from 4:00am, which is 11:00 after the power supply turns on. The constant current level remains till 6:30am, which is 14:00 after the power supply turns on.

Ex: © D03-Type: the profile recommended for tunnel lighting

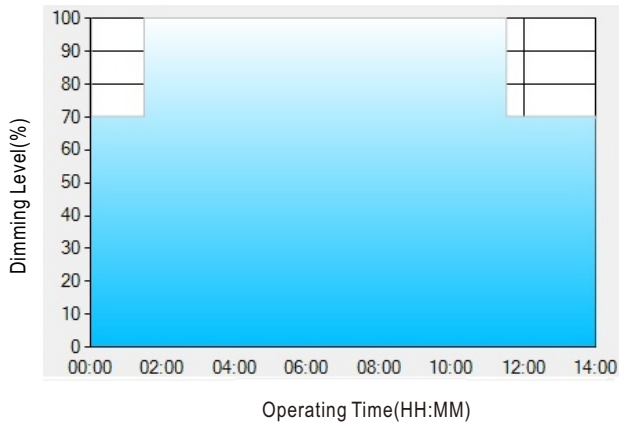

Set up for D03-Type in Smart timer dimming software program:

|         | T1    | T2    | T3  |
|---------|-------|-------|-----|
| TIME**  | 01:30 | 11:00 | --- |
| LEVEL** | 70%   | 100%  | 70% |

\*\* : TIME matches Operating Time in the diagram whereas LEVEL matches Dimming Level.

Example: If a tunnel lighting application adopts D03-Type, when turning on the power supply at 4:30pm, for instance:

[1] The power supply will switch to the constant current level at 70% starting from 4:30pm.

[2] The power supply will switch to the constant current level at 100% in turn, starting from 6:00pm, which is 01:30 after the power supply turns on.

[3] The power supply will switch to the constant current level at 70% in turn, starting from 5:00am, which is 11:00 after the power supply turns on.

The constant current level remains till 6:30am, which is 14:00 after the power supply turns on.

**OUTPUT LOAD vs TEMPERATURE(Nota.9)**

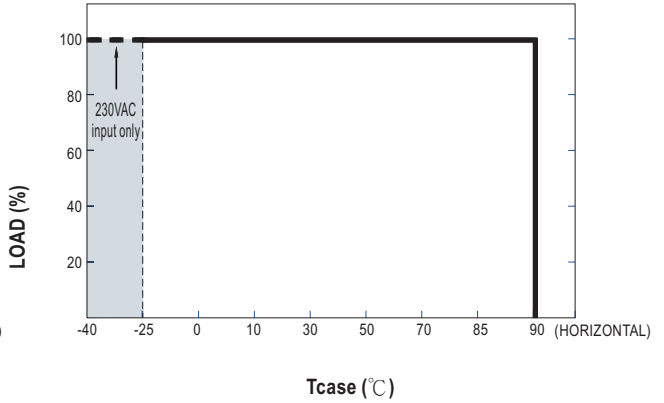
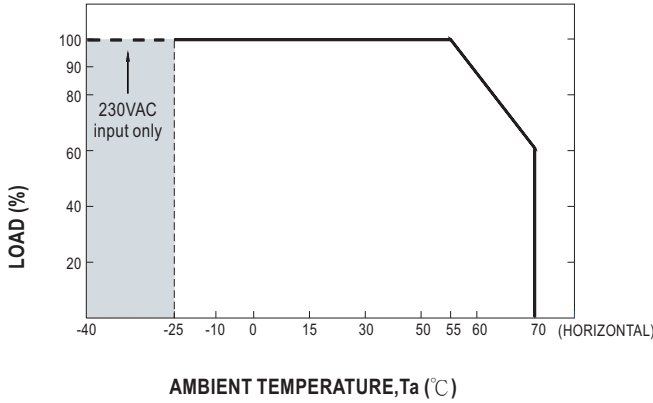

**STATIC CHARACTERISTIC**

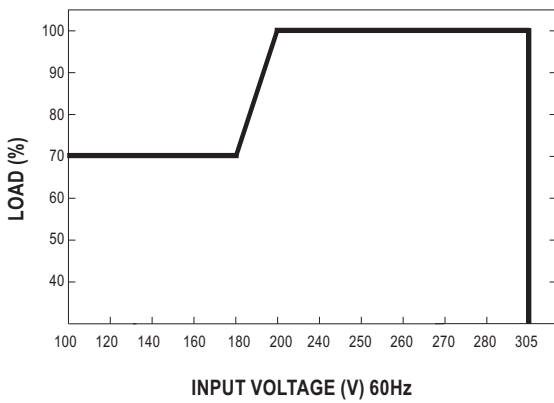

※ De-rating is needed under low input voltage.

**POWER FACTOR (PF) CHARACTERISTIC**

※ Tcase at 80°C

Constant Current Mode

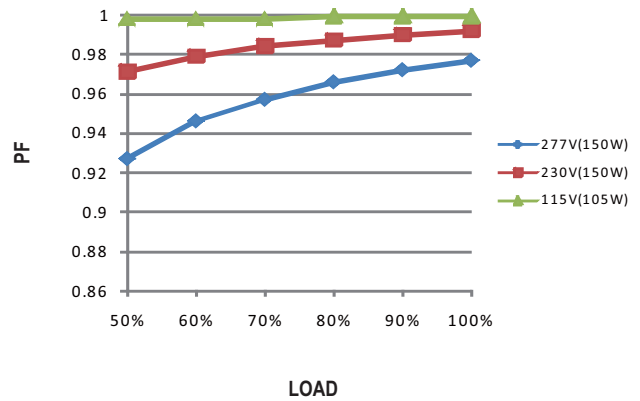

**TOTAL HARMONIC DISTORTION (THD)**

※ 54V Model, Tcase at 80°C

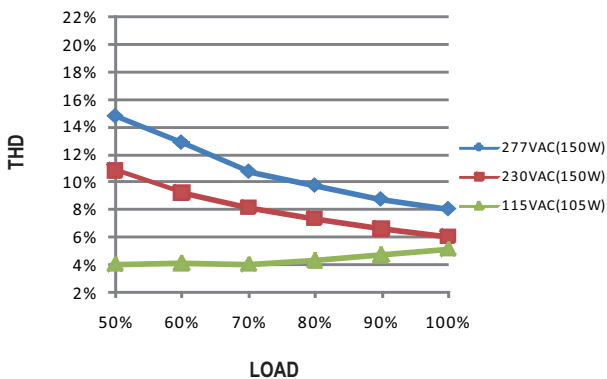

**EFFICIENCY vs LOAD**

ELG-150 series possess superior working efficiency that up to 91% can be reached in field applications.

※ 54V Model, Tcase at 80°C

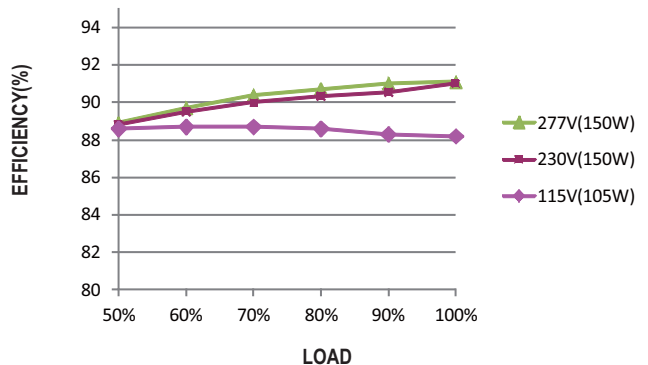



■ LIFE TIME

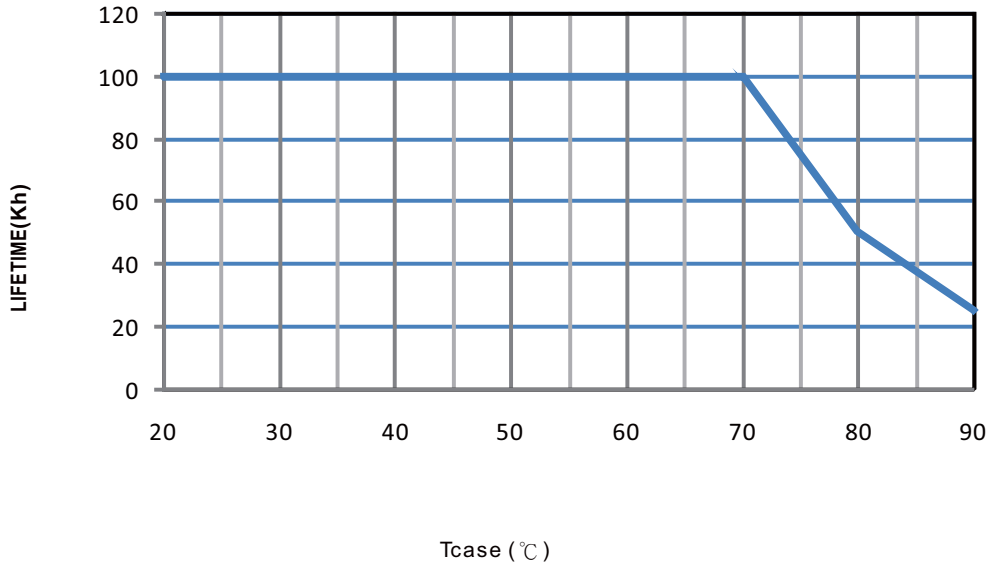

■ Mechanical Specification

※ Blank-Type

CASE NO.: 237A Unit:mm Tolerance:±1

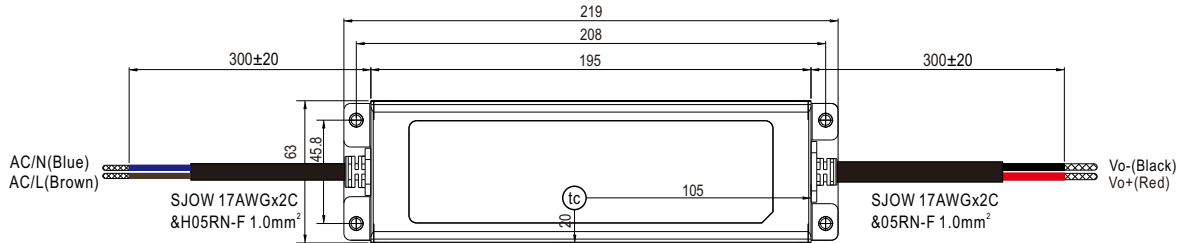

• (tc) : Max. Case Temperature



※ A-Type

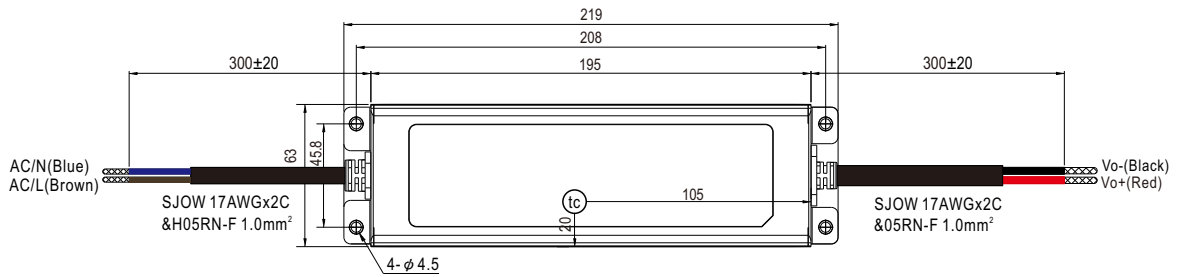

• (tc) : Max. Case Temperature



※ **AB-Type**

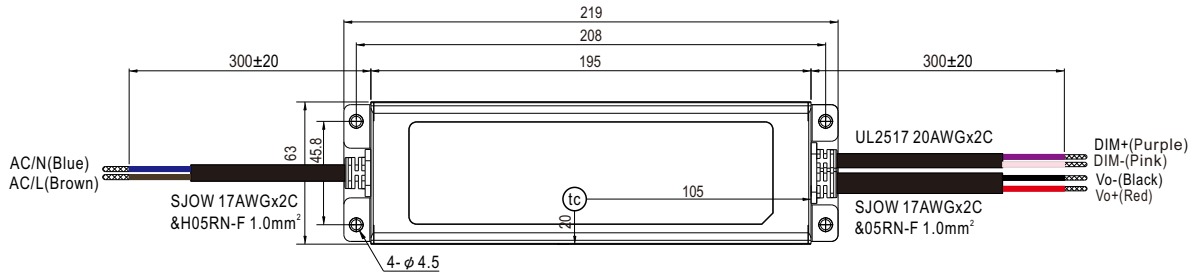

• (tc) : Max. Case Temperature

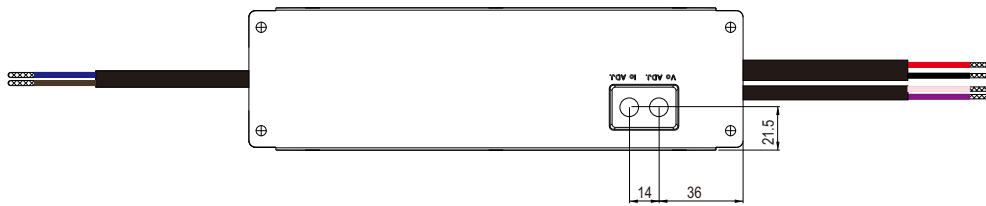

※ **B/DA/D2-Type**

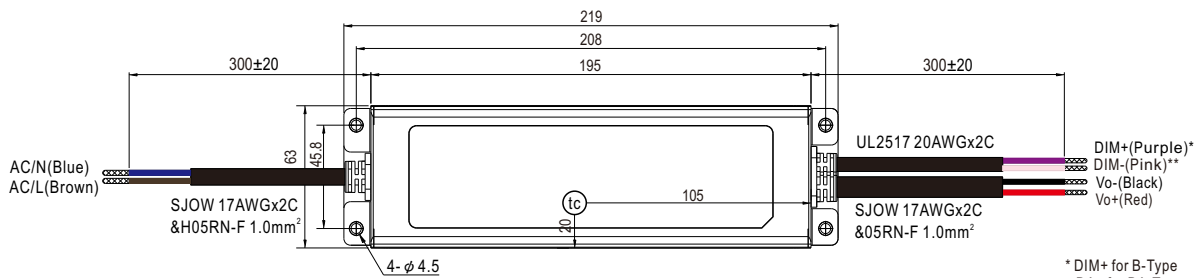

• (tc) : Max. Case Temperature

\* DIM+ for B-Type  
DA+ for DA-Type  
PROG+ for D2-Type  
\*\* DIM- for B-Type  
DA- for DA-Type  
PROG- for D2-Type



※ 3Y Model (3-wire input)

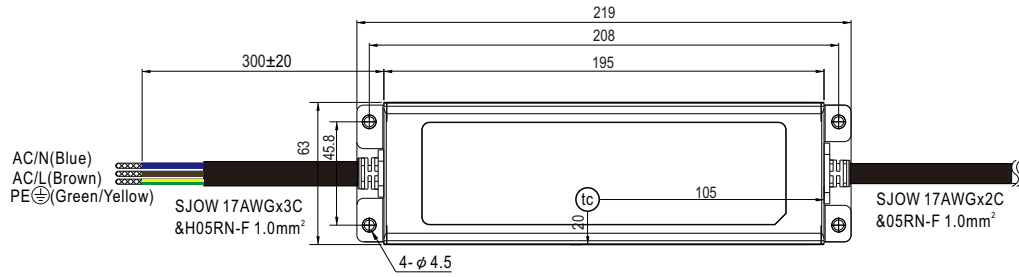

• (tc) : Max. Case Temperature

◎ Note1: Please connect the case to PE for the complete EMC deliverance and safety use.

◎ Note2: Please contact MEAN WELL for input wiring option with PE.

■ Recommend Mounting Direction

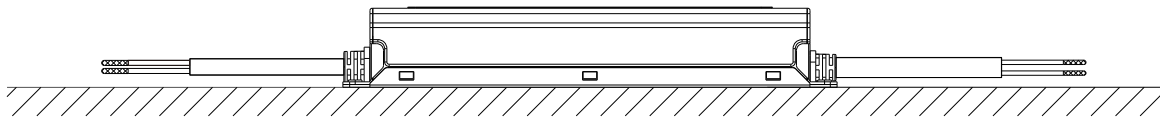

■ INSTALLATION MANUAL

Please refer to: <http://www.meanwell.com/manual.html>