



Наличие и актуальные цены на

EPP-120S-12

<https://www.mean-well.ru/store/EPP-120S-12/>



■ Features

- 3"x2" Compact Size
- 120W convection, 150W peak (10sec.)
- EMI for both Class I & Class II configuration
- -30~+85°C wide range operating temperature
- No load power consumption<0.3W
- High efficiency up to 94%
- Protections: Short circuit / Overload / Over voltage / Over temperature
- Operating altitude up to 5000 meters (Note.5)
- 3 years warranty

■ Applications

- Industrial automation machinery
- Industrial control system
- Mechanical and electrical equipment
- Electronic instruments, equipments or apparatus

■ GTIN CODE

MW Search: <https://www.meanwell.com/serviceGTIN.aspx>

■ Description

EPP-120S is a 120W highly reliable green PCB type power supply with a high power density on the 3" by 2" footprint. It accepts 80~264VAC input and offers various output voltages between 12V and 48V. The working efficiency is up to 94% and the extremely low no load power consumption is down below 0.3W. EPP-120S is able to be used for both Class I (with FG) and Class II (no FG) system design. EPP-120S has the complete protection functions; it is complied with the international safety regulations such as TUV BS EN/EN62368-1, BS EN/EN60335-1, UL62368-1 and IEC62368-1. EPP-120S series serves as a high price-to-performance power supply solution for various industrial applications.

■ Model Encoding

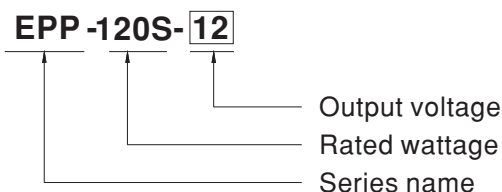

SPECIFICATION

MODEL	EPP-120S-12		EPP-120S-15		EPP-120S-24		EPP-120S-27		EPP-120S-48			
OUTPUT	DC VOLTAGE		12V		15V		24V		27V		48V	
	CURRENT	Peak(10 sec.)	11.8A		9.5A		6.25A		5.55A		3.125A	
		Convection	9.5A		7.6A		5A		4.44A		2.5A	
	RATED POWER	Peak(10 sec.)	141.6W		142.5W		150W		149.8W		150W	
		Convection	114W		114W		120W		119.9W		120W	
	RIPPLE & NOISE (max.) Note.2		100mVp-p		120mVp-p		150mVp-p		150mVp-p		200mVp-p	
	VOLTAGE ADJ. RANGE		11.4~12.6V		14.3~15.8V		22.8~25.2V		25.6 ~ 28.4V		45.6 ~50.4V	
	VOLTAGE TOLERANCE Note.3		±2.0%		±2%		±1.0%		±1.0%		±1.0%	
	LINE REGULATION		±0.5%		±0.5%		±0.5%		±0.5%		±0.5%	
	LOAD REGULATION		±1.0%		±1.0%		±1.0%		±1.0%		±1.0%	
SETUP, RISE TIME		600ms, 30ms/230VAC		600ms, 30ms/115VAC at full load								
HOLD UP TIME (Typ.)		15ms/230VAC		15ms/115VAC at full load								
INPUT	VOLTAGE RANGE Note.4		80 ~ 264VAC		113 ~ 370VDC							
	FREQUENCY RANGE		47 ~ 63Hz									
	POWER FACTOR		PF>0.94/230VAC		PF>0.98/115VAC at full load							
	EFFICIENCY (Typ.)		91%		92%		93%		94%		93.5%	
	AC CURRENT (Typ.)		2.3A/115VAC		1.1A/230VAC							
	INRUSH CURRENT (Typ.)		COLD START 30A/115VAC		60A/230VAC							
	LEAKAGE CURRENT		<0.75mA / 240VAC									
PROTECTION	OVERLOAD		130~160% rated output power		Protection type : Hiccup mode, recovers automatically after fault condition is removed							
	OVER VOLTAGE		13.2 ~ 15.6V		16.5 ~ 19.5V		26.4 ~ 31.2V		29.7 ~ 35V		52.8 ~ 62.4V	
	OVER TEMPERATURE		Protection type : Shut down o/p voltage, recovers automatically after temperature goes down									
ENVIRONMENT	WORKING TEMP.		-30 ~ +85°C (Refer to "Derating Curve")									
	WORKING HUMIDITY		20 ~ 90% RH non-condensing									
	STORAGE TEMP.		-40 ~ +85°C									
	TEMP. COEFFICIENT		±0.03%/°C (0 ~ 50°C)									
	VIBRATION		10 ~ 500Hz, 2G 10min./1cycle, 60min. each along X, Y, Z axes									
	OPERATING ALTITUDE (Note.5)		5000 meters									
SAFETY & EMC (Note 6)	SAFETY STANDARDS		UL62368-1, TUV BS EN/EN62368-1, BS EN/EN60335-1, IEC62368-1, CCC GB4943.1, EAC TP TC 004 approved									
	WITHSTAND VOLTAGE		I/P-O/P:4KVAC I/P-FG:2KVAC O/P-FG:1.5KVAC									
	ISOLATION RESISTANCE		I/P-O/P, I/P-FG, O/P-FG: 100M Ohms / 500VDC / 25°C / 70% RH									
	EMC EMISSION		GB9254.1 Class B,GB17625 Class A									
			Parameter		Standard				Test Level / Note			
			Conducted emission		BS EN/EN55032 (CISPR32)				Class B			
			Radiated emission		BS EN/EN55032 (CISPR32)				Class I : Class B , Class II : Class A			
			Harmonic current		BS EN/EN61000-3-2				Class A			
	Voltage flicker		BS EN/EN61000-3-3				-----					
	EMC IMMUNITY		BS EN/EN55035, BS EN/EN61000-6-2									
Parameter			Standard				Test Level / Note					
ESD			BS EN/EN61000-4-2				Level 3, 8KV air ; Level 3, 4KV contact					
RF field susceptibility			BS EN/EN61000-4-3				Level 3, 10V/m(80MHz~2.7GHz) Table 9, 9~28V/m(385MHz~5.78GHz)					
EFT bursts			BS EN/EN61000-4-4				Level 3, 2KV					
Surge susceptibility			BS EN/EN61000-4-5				Level 4, 4KV/Line-FG; 2KV/Line-Line					
Conducted susceptibility			BS EN/EN61000-4-6				Level 3, 10V					
Magnetic field immunity			BS EN/EN61000-4-8				Level 4, 30A/m					
Voltage dip, interruption		BS EN/EN61000-4-11				95% dip 0.5 periods, 30% dip 25 periods, 95% interruptions 250 periods						
OTHERS	MTBF		4071.1K hrs min. Telcordia SR-332 (Bellcore) ; 470.2K hrs min. MIL-HDBK-217F (25°C)									
	DIMENSION		76.2*50.8*28mm (L*W*H) or 3" * 2" *1.1" inch									
	PACKING		0.13Kg; 100pcs/14Kg/1.13CUFT									
NOTE	<p>1. All parameters NOT specially mentioned are measured at 230VAC input, rated load and 25 of ambient temperature.</p> <p>2. Ripple & noise are measured at 20MHz of bandwidth by using a 12" twisted pair-wire terminated with a 0.1uf & 47uf parallel capacitor.</p> <p>3. Tolerance : includes set up tolerance, line regulation and load regulation.</p> <p>4. Derating may be needed under low input voltages. Please check the derating curve for more details.</p> <p>5. The ambient temperature derating of 3.5°C/1000m with fanless models and of 5°C/1000m with fan models for operating altitude higher than 2000m(6500ft).</p> <p>6. The power supply is considered a component which will be installed into a final equipment. All the EMC tests are been executed by mounting the unit on a 360mm*360mm metal plate with 1mm of thickness. The final equipment must be re-confirmed that it still meets EMC directives. For guidance on how to perform these EMC tests, please refer to "EMI testing of component power supplies." (as available on http://www.meanwell.com)</p> <p>※ Product Liability Disclaimer : For detailed information, please refer to https://www.meanwell.com/serviceDisclaimer.aspx</p>											



Block Diagram

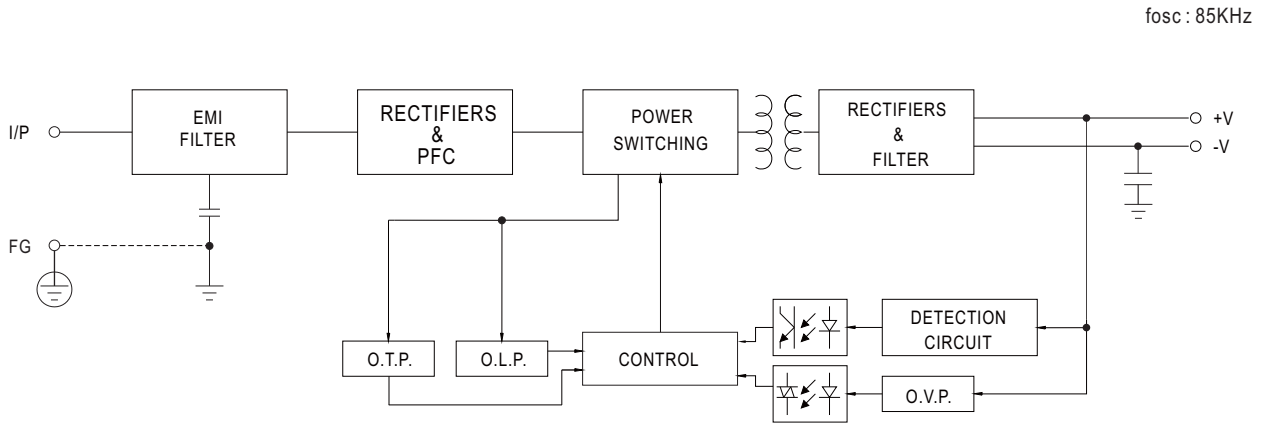

Derating Curve

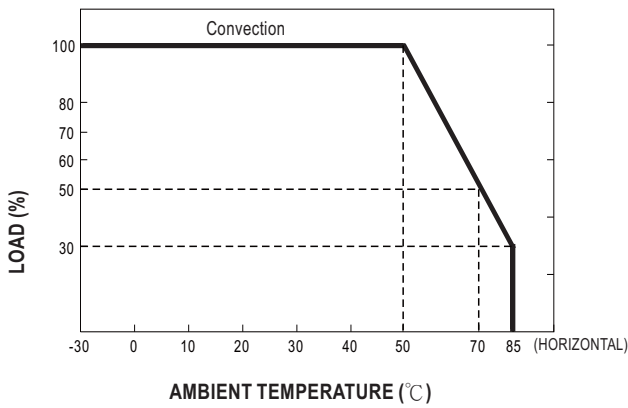

Output Derating VS Input Voltage

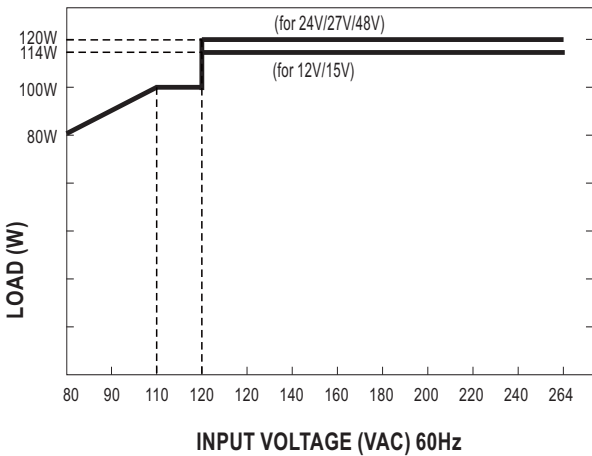

■ Mechanical Specification

Unit:mm

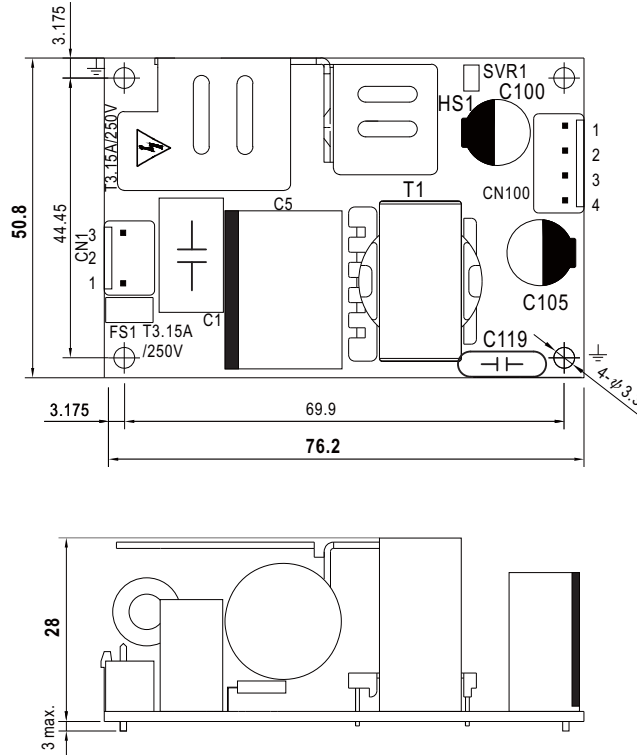

AC Input Connector (CN1) : JST B3P-VH or equivalent

Pin No.	Assignment	Mating Housing	Terminal
1	AC/L	JST VHR or equivalent	JST SVH-21T-P1.1 or equivalent
2	No Pin		
3	AC/N		

DC Output Connector (CN100) : JST B4P-VH or equivalent

Pin No.	Assignment	Mating Housing	Terminal
1,2	+V	JST VHR or equivalent	JST SVH-21T-P1.1 or equivalent
3,4	-V		

⚠ 1.HS1 must have safety isolation distance with system case.

※Note :

- 1.EPP-120S model delivers EMI Class B for both conducted emission and radiated emission for the power supply, when configured into Class I (with FG) system.
- 2.EPP-120S model delivers EMI Class B conducted emission and Class A radiated emission with King Core K5B RC (12*15*7) in output cable for the power supply when configured into Class II (no FG) system.

■ Installation Manual

Please refer to : <http://www.meanwell.com/manual.html>