



Наличие и актуальные цены на

**RSD-60L-3.3**

<https://www.mean-well.ru/store/RSD-60L-3.3/>



**Features**

- Compliance to BS EN/EN50155 and BS EN/EN45545-2 railway standard
- Ultra compact and 1U low profile(25mm)
- 4:1 wide input range
- No minimum load required
- Protections: Short circuit / Overload / Over voltage / Input reverse polarity
- 4000VDC I/O isolation (Reinforced isolation)
- Half encapsulated , cooling by free air convection
- -40~+70°C wide working temperature
- Built-in constant current limiting circuit
- LED indicator for power on
- 3 years warranty

**Applications**

- Bus, tram, metro or railway system
- Highly vibrating, highly dusty, extremely low or high temperature harsh environment
- Wireless network
- Telecom or datacom system
- Industry control system

**GTIN CODE**

MW Search: <https://www.meanwell.com/serviceGTIN.aspx>

**Description**

RSD-60 is a 60W enclosed type DC-DC reliable railway converter. This series is compliant with BS EN/EN50155/ IEC60571 railway standard, constituting three types of models with 4:1 wide but different input ranges 9~36V/18~72V/40~160V, suitable for railway and all kinds of transportation systems exploiting the frequently used standard input voltages such as 12V, 24V, 36V, 48V, 72V, 96V and 110V. Various output voltages, 3.3V, 5V, 12V and 24V are available for selection.

This series has the capability of working under -40~+70°C, low ripple and noise, supreme EMC characteristics, 4KVDC I/P-OP, low enclosure profile 25mm and an interior with semi-potted silicone. It does not only well fits the in-car systems or the facilities by rails for railway, trams and buses but also can be used in the harsh environment with high vibration, high dust, extremely low or high temperature, etc.

**Model Encoding**

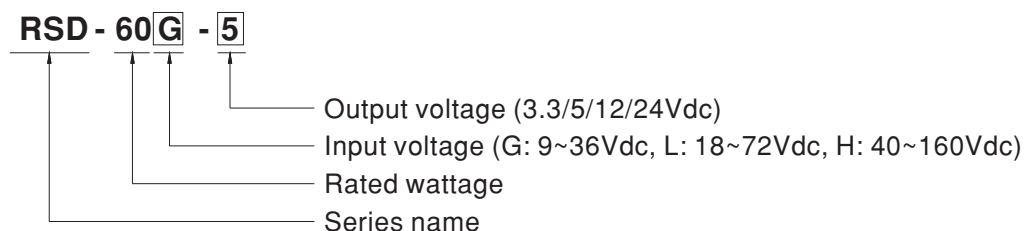



**SPECIFICATION**

| MODEL                 | RSD-60G-3.3  | RSD-60G-5   | RSD-60G-12        | RSD-60G-24   | RSD-60L-3.3  | RSD-60L-5                                       | RSD-60L-12                                | RSD-60L-24   |              |  |
|-----------------------|--|---|-------------------|--------------|--------------|---|---|--------------|--------------|--|
| OUTPUT                | DC VOLTAGE   | 3.3V  | 5V                | 12V          | 24V          | 3.3V  | 5V  | 12V          | 24V          |  |
|                       | RATED CURRENT  | 12A   | 12A               | 5A           | 2.5A         | 12A   | 12A                                       | 5A           | 2.5A         |  |
|                       | CURRENT RANGE  | 0 ~ 12A   | 0 ~ 12A           | 0 ~ 5A       | 0 ~ 2.5A     | 0 ~ 12A   | 0 ~ 12A                                   | 0 ~ 5A       | 0 ~ 2.5A     |  |
|                       | RATED POWER  | 39.6W   | 60W               | 60W          | 60W          | 39.6W   | 60W                                       | 60W          | 60W          |  |
|                       | RIPPLE & NOISE (max.) Note.2   | 60mVp-p   | 100mVp-p          | 50mVp-p      | 50mVp-p      | 60mVp-p   | 60mVp-p                                   | 50mVp-p      | 50mVp-p      |  |
|                       | VOLTAGE TOLERANCE Note.3   | ±2.0%   | ±2.0%             | ±2.0%        | ±2.0%        | ±2.0%   | ±2.0%                                     | ±2.0%        | ±2.0%        |  |
|                       | LINE REGULATION  | ±0.5%   | ±0.5%             | ±0.3%        | ±0.2%        | ±0.5%   | ±0.5%                                     | ±0.3%        | ±0.2%        |  |
|                       | LOAD REGULATION  | ±0.5%   | ±0.5%             | ±0.3%        | ±0.2%        | ±0.5%   | ±0.5%                                     | ±0.3%        | ±0.2%        |  |
|                       | SETUP, RISE TIME   | 100ms, 60ms at full load  |                   |              |              |   |   |              |              |  |
|                       | HOLD UP TIME (Typ.)  | Please refer to page 5 Hold up Time( Load de-rating curve )   |                   |              |              |   |   |              |              |  |
| INPUT                 | VOLTAGE RANGE CONTINUOUS   | 9 ~ 36VDC   |                   |              |              | 18 ~ 72VDC                                      |   |              |              |  |
|                       | EFFICIENCY (Typ.)  | 86.5%   | 88%               | 92%          | 90%          | 88.5%   | 89%                                       | 93%          | 91.5%        |  |
|                       | DC CURRENT (Typ.)  | 2.1A/24VDC 3A/24VDC   |                   |              |              | 0.95A/48VDC 1.5A/48VDC                          |   |              |              |  |
|                       | INRUSH CURRENT (Typ.)  | 20A/24VDC   |                   |              |              | 20A/48VDC                                       |   |              |              |  |
|                       | INTERRUPTION OF VOLTAGE SUPPLY   | EN50155:2021-Comply with S1 level   |                   |              |              |   |   |              |              |  |
| PROTECTION            | OVERLOAD   | 105 ~ 135% rated output power<br>Protection type : Constant current limiting, recovers automatically after fault condition is removed |                   |              |              |   |   |              |              |  |
|                       | OVER VOLTAGE   | 4.3 ~ 5.3V  | 5.75 ~ 7V         | 13.8 ~ 16.2V | 27.6 ~ 32.4V | 4.3 ~ 4.95V                                     | 5.75 ~ 7V                                 | 13.8 ~ 16.2V | 27.6 ~ 32.4V |  |
| ENVIRONMENT           | WORKING TEMP.  | -40 ~ +55°C (no derating) ; +70°C @ 60% load by free air convection ; +70°C (no derating with external base plate)                    |                   |              |              |   |   |              |              |  |
|                       | WORKING HUMIDITY   | 5 ~ 95% RH non-condensing   |                   |              |              |   |   |              |              |  |
|                       | STORAGE TEMP.  | -40 ~ +85°C   |                   |              |              |   |   |              |              |  |
|                       | TEMP. COEFFICIENT  | ±0.03%/°C (0 ~ 50°C)  |                   |              |              |   |   |              |              |  |
|                       | VIBRATION  | 10 ~ 500Hz, 5G 10min./1cycle, 60min. each along X, Y, Z axes ; Mounting : compliance to IEC61373                                      |                   |              |              |   |   |              |              |  |
|                       | OPERATING ALTITUDE   | 5000 meters   |                   |              |              |   |   |              |              |  |
| SAFETY & EMC (Note 4) | SAFETY STANDARDS   | IEC 62368-1, UL 62368-1, AS/NZS 62368-1, EAC TP TC 004 approved, Design refer to BS EN/EN62368-1                                      |                   |              |              |   |   |              |              |  |
|                       | WITHSTAND VOLTAGE  | I/P-O/P:4KVDC I/P-FG:2.5KVDC O/P-FG:2.5KVDC   |                   |              |              |   |   |              |              |  |
|                       | ISOLATION RESISTANCE   | I/P-O/P, I/P-FG, O/P-FG:100M Ohms / 500VDC / 25°C / 70% RH  |                   |              |              |   |   |              |              |  |
|                       | EMC EMISSION   | Parameter   | Standard          |              |              |   | Test Level / Note                         |              |              |  |
|                       |  | Conducted   | BS EN/EN55032     |              |              |   | Class A                                   |              |              |  |
|                       |  | Radiated  | BS EN/EN55032     |              |              |   | Class B                                   |              |              |  |
|                       |  | Harmonic Current  | BS EN/EN61000-3-2 |              |              |   | -----                                     |              |              |  |
|                       |  | Voltage Flicker   | BS EN/EN61000-3-3 |              |              |   | -----                                     |              |              |  |
|                       | EMC IMMUNITY   | BS EN/EN55035   |                   |              |              |   |   |              |              |  |
|                       |  | Parameter   | Standard          |              |              |   | Test Level / Note                         |              |              |  |
|                       |  | ESD   | BS EN/EN61000-4-2 |              |              |   | Level 3, ±8KV air ; Level 3, ±6KV contact |              |              |  |
|                       |  | Radiated Field  | BS EN/EN61000-4-3 |              |              |   | Level X, 20V/m                            |              |              |  |
| EFT / Burst           |  | BS EN/EN61000-4-4   |                   |              |              | Level 3, 2KV at power                           |   |              |              |  |
| Surge                 |  | BS EN/EN61000-4-5   |                   |              |              | Level 3, 1KV Line-Line, Level 3, 2KV Line-Earth |   |              |              |  |
| Conducted             |  | BS EN/EN61000-4-6   |                   |              |              | Level 3   |   |              |              |  |
| RAILWAY STANDARD      | Compliance to BS EN/EN45545-2 for fire protection ; BS EN/EN50155 / IEC60571 including IEC61373 for shock & vibration, BS EN/EN50121-3-2 for EMC   |   |                   |              |              |   |   |              |              |  |
| OTHERS                | MTBF   | 2738.8K hrs min. Telcordia SR-332 (Bellcore) ; 593.9K hrs min. MIL-HDBK-217F (25°C)   |                   |              |              |   |   |              |              |  |
|                       | DIMENSION  | 128*60*25mm (L*W*H)   |                   |              |              |   |   |              |              |  |
|                       | PACKING  | 0.29Kg; 48pcs/14.9Kg/0.75CUFT   |                   |              |              |   |   |              |              |  |
| NOTE                  | <p>1. All parameters NOT specially mentioned are measured at 24.48VDC input, rated load and 25°C of ambient temperature.</p> <p>2. Ripple &amp; noise are measured at 20MHz of bandwidth by using a 12" twisted pair-wire terminated with a 0.1 μ F &amp; 47 μ F parallel capacitor.</p> <p>3. Tolerance : includes set up tolerance, line regulation and load regulation.</p> <p>4. The power supply is considered a component which will be installed into a final equipment. All the EMC tests are been executed by mounting the unit on a 360mm*360mm metal plate with 1mm of thickness. The final equipment must be re-confirmed that it still meets EMC directives. For guidance on how to perform these EMC tests, please refer to "EMI testing of component power supplies."<br/>(as available on <a href="https://www.meanwell.com/Upload/PDF/EMI_statement_en.pdf">https://www.meanwell.com/Upload/PDF/EMI_statement_en.pdf</a> )</p> <p>5. Strongly recommended that external output capacitance should not exceed 5000uF.</p> <p>6. The ambient temperature derating of 3.5°C/1000m with fanless models and of 5°C/1000m with fan models for operating altitude higher than 2000m(6500ft).</p> <p>※ Product Liability Disclaimer : For detailed information, please refer to <a href="https://www.meanwell.com/serviceDisclaimer.aspx">https://www.meanwell.com/serviceDisclaimer.aspx</a></p> |   |                   |              |              |   |   |              |              |  |

**SPECIFICATION**

| MODEL                    | RSD-60H-3.3  | RSD-60H-5   | RSD-60H-12        | RSD-60H-24                                      |   |
|--------------------------|--|---|-------------------|---|---|
| OUTPUT                   | DC VOLTAGE   | 3.3V  | 5V                | 12V   | 24V                                       |
|                          | RATED CURRENT  | 12A   | 12A               | 5A  | 2.5A                                      |
|                          | CURRENT RANGE  | 0 ~ 12A   | 0 ~ 12A           | 0 ~ 5A  | 0 ~ 2.5A                                  |
|                          | RATED POWER  | 39.6W   | 60W               | 60W   | 60W                                       |
|                          | RIPPLE & NOISE (max.) Note.2   | 80mVp-p   | 60mVp-p           | 50mVp-p   | 50mVp-p                                   |
|                          | VOLTAGE TOLERANCE Note.3   | ±2.0%   | ±2.0%             | ±2.0%   | ±2.0%                                     |
|                          | LINE REGULATION  | ±0.5%   | ±0.5%             | ±0.3%   | ±0.2%                                     |
|                          | LOAD REGULATION  | ±0.5%   | ±0.5%             | ±0.3%   | ±0.2%                                     |
|                          | SETUP, RISE TIME   | 100ms, 60ms at full load  |                   |   |   |
|                          | HOLD UP TIME (Typ.)  | Please refer to page 5 Hold up Time( Load de-rating curve )   |                   |   |   |
| INPUT                    | VOLTAGE RANGE CONTINUOUS   | 40 ~ 160VDC   |                   |   |   |
|                          | EFFICIENCY (Typ.)  | 87.5%   | 89%               | 92.5%   | 91.5%                                     |
|                          | DC CURRENT (Typ.)  | 0.415A/110VDC   | 0.62A/110V        |   |   |
|                          | INRUSH CURRENT (Typ.)  | 20A/110VDC  |                   |   |   |
|                          | INTERRUPTION OF VOLTAGE SUPPLY   | EN50155:2021-Comply with S1 level   |                   |   |   |
| PROTECTION               | OVERLOAD   | 105 ~ 135% rated output power<br>Protection type : Constant current limiting, recovers automatically after fault condition is removed |                   |   |   |
|                          | OVER VOLTAGE   | 4.3 ~ 4.95V   | 5.75 ~ 7V         | 13.8 ~ 16.2V                                    | 27.6 ~ 32.4V                              |
|                          |  | Protection type : Shut down o/p voltage, re-power on to recover   |                   |   |   |
| ENVIRONMENT              | WORKING TEMP.  | -40 ~ +55°C (no derating) ; +70°C @ 60% load by free air convection ; +70°C (no derating with external base plate)                    |                   |   |   |
|                          | WORKING HUMIDITY   | 5 ~ 95% RH non-condensing   |                   |   |   |
|                          | STORAGE TEMP.  | -40 ~ +85°C   |                   |   |   |
|                          | TEMP. COEFFICIENT  | ±0.03%/°C (0 ~ 50°C)  |                   |   |   |
|                          | VIBRATION  | 10 ~ 500Hz, 5G 10min./1cycle, 60min. each along X, Y, Z axes ; Mounting : compliance to IEC61373                                      |                   |   |   |
|                          | OPERATING ALTITUDE   | 5000 meters   |                   |   |   |
| SAFETY & EMC<br>(Note 4) | SAFETY STANDARDS   | IEC 62368-1, UL 62368-1, AS/NZS 62368-1, EAC TP TC 004 approved, Design refer to BS EN/EN62368-1                                      |                   |   |   |
|                          | WITHSTAND VOLTAGE  | I/P-O/P:4KVDC I/P-FG:2.5KVDC O/P-FG:2.5KVDC   |                   |   |   |
|                          | ISOLATION RESISTANCE   | I/P-O/P, I/P-FG, O/P-FG:100M Ohms / 500VDC / 25°C / 70% RH  |                   |   |   |
|                          | EMC EMISSION   | Parameter   | Standard          |   | Test Level / Note                         |
|                          |  | Conducted   | BS EN/EN55032     |   | Class A                                   |
|                          |  | Radiated  | BS EN/EN55032     |   | Class B                                   |
|                          |  | Harmonic Current  | BS EN/EN61000-3-2 |   | -----                                     |
|                          |  | Voltage Flicker   | BS EN/EN61000-3-3 |   | -----                                     |
|                          | EMC IMMUNITY   | BS EN/EN55035   |                   |   |   |
|                          |  | Parameter   | Standard          |   | Test Level / Note                         |
|                          |  | ESD   | BS EN/EN61000-4-2 |   | Level 3, ±8KV air ; Level 3, ±6KV contact |
|                          |  | Radiated Field  | BS EN/EN61000-4-3 |   | Level X, 20V/m                            |
|                          |  | EFT / Burst   | BS EN/EN61000-4-4 |   | Level 3, 2KV at power                     |
| Surge                    |  | BS EN/EN61000-4-5   |                   | Level 3, 1KV Line-Line, Level 3, 2KV Line-Earth |   |
| Conducted                |  | BS EN/EN61000-4-6   |                   | Level 3   |   |
| RAILWAY STANDARD         | Compliance to BS EN/EN45545-2 for fire protection ; BS EN/EN50155 / IEC60571 including IEC61373 for shock & vibration, BS EN/EN50121-3-2 for EMC   |   |                   |   |   |
| OTHERS                   | MTBF   | 2738.8K hrs min. Telcordia SR-332 (Bellcore) ; 593.9K hrs min. MIL-HDBK-217F (25°C)   |                   |   |   |
|                          | DIMENSION  | 128*60*25mm (L*W*H)   |                   |   |   |
|                          | PACKING  | 0.29Kg; 48pcs/14.9Kg/0.75CUFT   |                   |   |   |
| NOTE                     | <p>1. All parameters NOT specially mentioned are measured at 110VDC input, rated load and 25°C of ambient temperature.</p> <p>2. Ripple &amp; noise are measured at 20MHz of bandwidth by using a 12" twisted pair-wire terminated with a 0.1 μ F &amp; 47 μ F parallel capacitor.</p> <p>3. Tolerance : includes set up tolerance, line regulation and load regulation.</p> <p>4. The power supply is considered a component which will be installed into a final equipment. All the EMC tests are been executed by mounting the unit on a 360mm*360mm metal plate with 1mm of thickness. The final equipment must be re-confirmed that it still meets EMC directives. For guidance on how to perform these EMC tests, please refer to "EMI testing of component power supplies."<br/>(as available on <a href="https://www.meanwell.com/Upload/PDF/EMI_statement_en.pdf">https://www.meanwell.com/Upload/PDF/EMI_statement_en.pdf</a> )</p> <p>5. Strongly recommended that external output capacitance should not exceed 5000uF.</p> <p>6. The ambient temperature derating of 3.5°C/1000m with fanless models and of 5°C/1000m with fan models for operating altitude higher than 2000m(6500ft).</p> <p>※ Product Liability Disclaimer : For detailed information, please refer to <a href="https://www.meanwell.com/serviceDisclaimer.aspx">https://www.meanwell.com/serviceDisclaimer.aspx</a></p> |   |                   |   |   |

**Block Diagram**

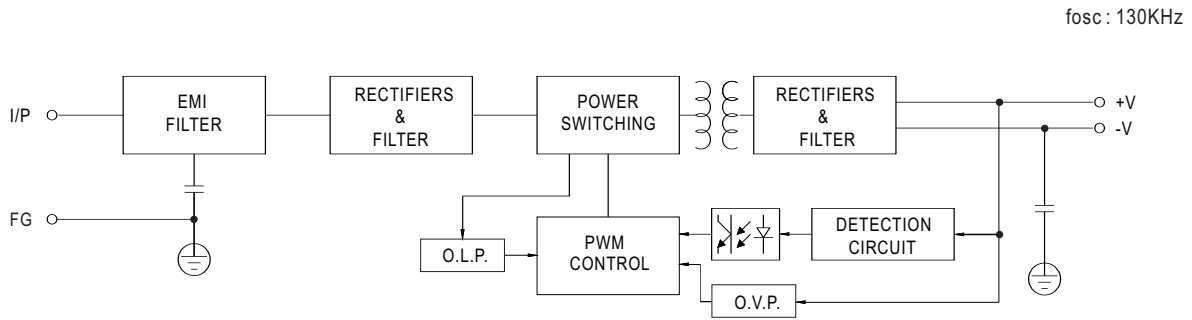

**Input Fuse**

There is one fuse connected in series to the positive input line, which is used to protect against abnormal surge. Fuse specifications of each model are shown as below.

| Type | Fuse Type | Reference and Rating   |
|------|-----------|------------------------|
| G    | Time-Lag  | CONQUE MST, 10A, 250V  |
| L    | Time-Lag  | CONQUE MST, 5A, 250V   |
| H    | Time-Lag  | CONQUE MST, 2.5A, 250V |

**Input Reverse Polarity Protection**

There is a MOSFET connected in series to the negative input line. If the input polarity is connected reversely, the MOSFET opens and there will be no output to protect the unit.

**Input Range and Transient Ability**

The series has a wide range input capability. With  $\pm 40\%$  of rated input voltage, it can withstand that for 1 second.

**Input Under-Voltage Protection**

If input voltage drops below  $V_{imin}$ , the internal control IC shuts down and there is no output voltage. It recovers automatically when input voltage reaches above  $V_{imin}$ , please refer to the cruve below.

RSD-60G-24

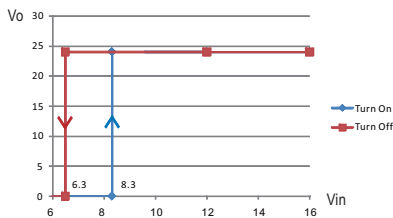

RSD-60L-24

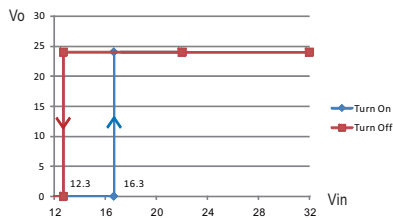

RSD-60H-24

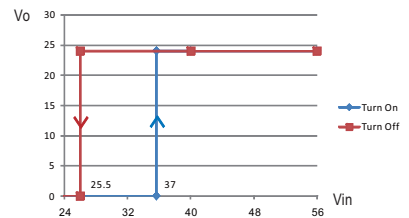

**Inrush Current**

Inrush current is suppressed by a resistor during the initial start-up, and then the resistor is bypassed by a MOSFET to reduce power consumption after accomplishing the start-up.

■ Hold-up Time

RSD-60G-3.3

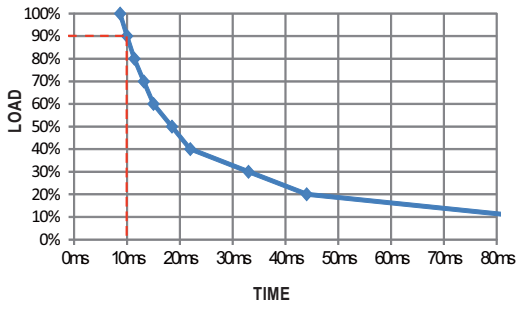

RSD-60G-5

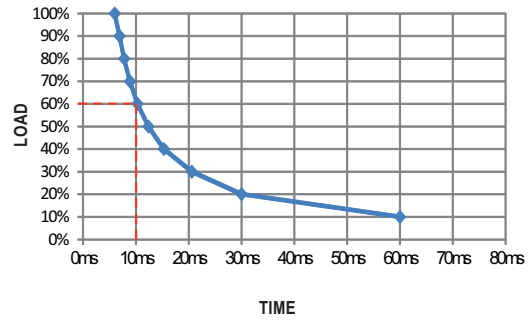

RSD-60G-12

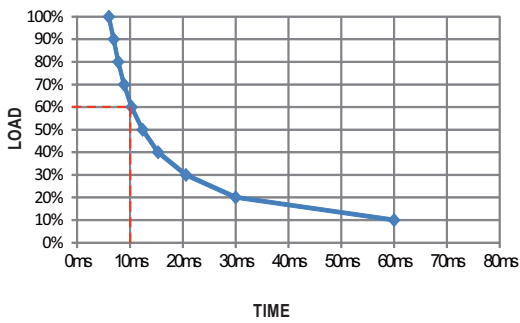

RSD-60G-24

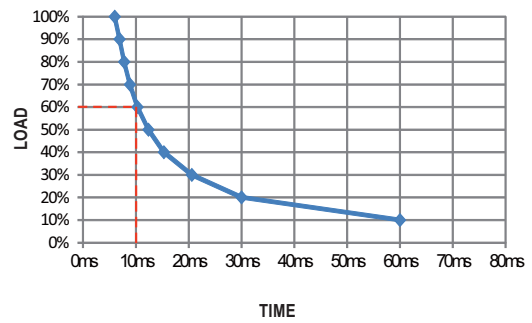

■ Output Voltage Adjustment

This function is optional, which the standard product does not have it. If you do need the function, please contact MW for details.

**Efficiency vs Load & Vin Curve**

The efficiency vs load & Vin curves of each model are shown as below.

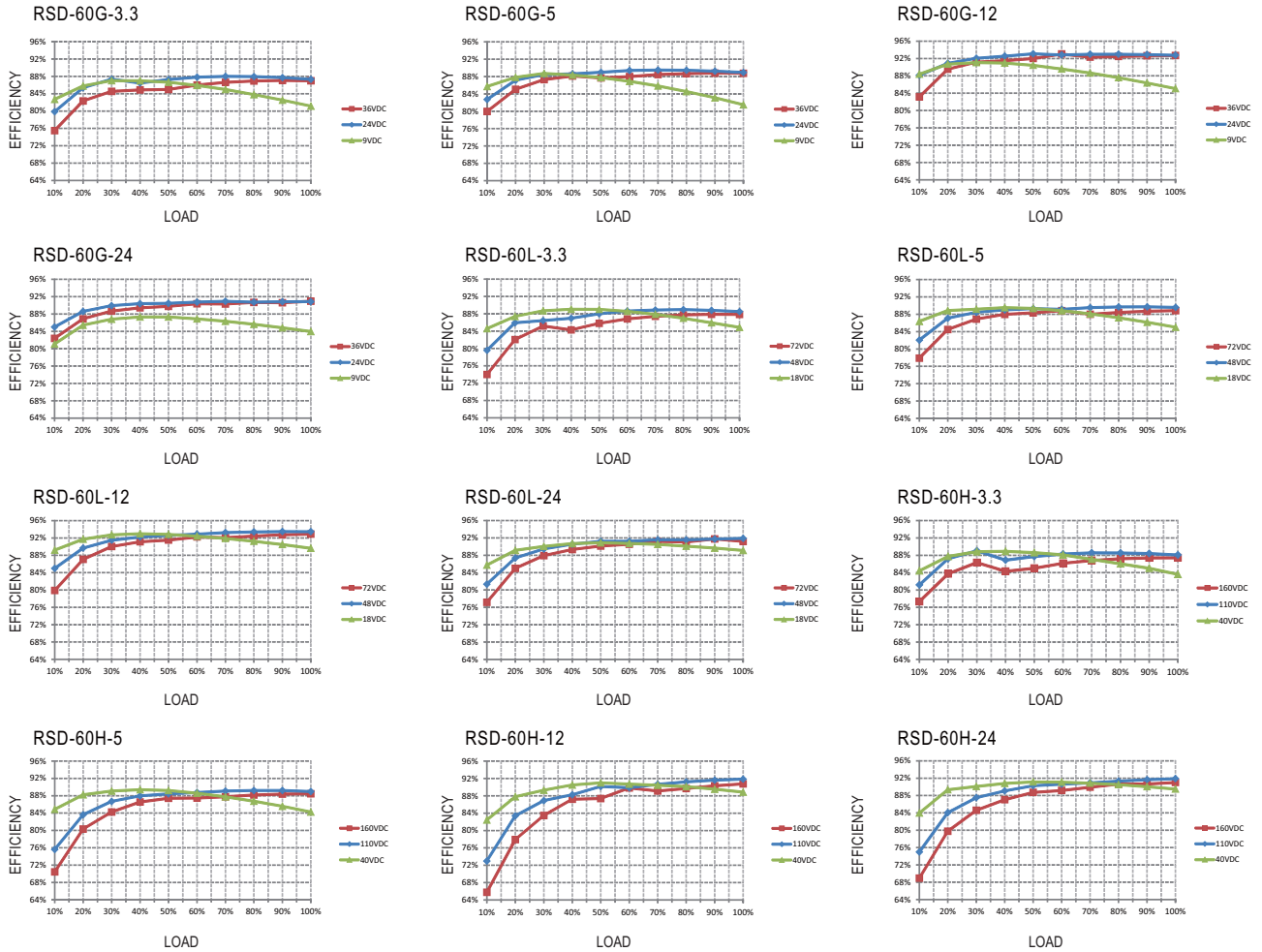

**Parallel and Series Connection**

**A. Operation in Parallel**

Since RSD-60 series don't have built-in parallel circuit, it can only use external circuits to achieve the redundant operation but not increase the current rating.

1. Add a diode at the positive-output of each power supply (as shown as below), the current rating of the diode should be larger than the maximum output current rating and attached to a suitable heat sink. This is only for redundant use (increase the reliability of the system) and users have to check suitability of the circuit by themselves.

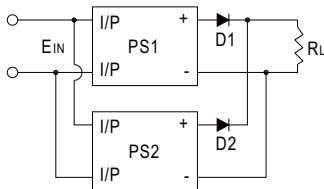

2. When using S.P.S. in parallel connection, the leakage current will increase at the same time. This could pose as a shock hazard for the user. So please contact the supplier if you have this kind of application.

**B. Operation in Series**

RSD-60 can be operated in series. Here are the methods of doing it:

1. Positive and negative terminals are connected as shown as below. According to the connection, you can get the positive and negative output voltages for your loads.

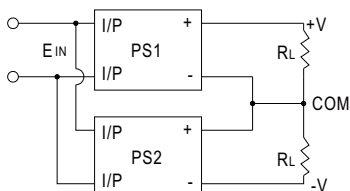

2. Increase the output voltage (current does not change). Because RSD-60 series have no reverse blocking diode in the unit, you should add an external blocking diode to prevent the damage of every unit while starting up. The voltage rating of the external diode should be larger than  $V1+V2$  (as shown as below).

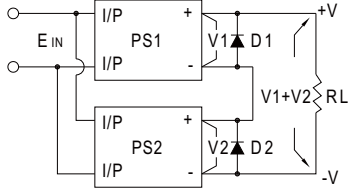

**Overload Protection**

If the output draw up to 105~135% of its output power rating, the converter will go into overload protection which is constant current mode. After the faulty condition is removed, it will recover automatically. Please refer to the diagram below for the detail operation characteristic. Please note that it's not suitable to operate within the overload region continuously, or it may cause to over temperature and reduce the life of the power supply unit or even damage it.

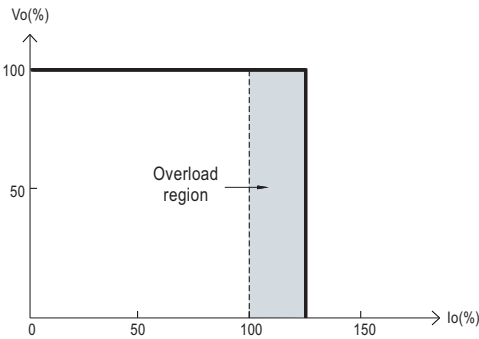

**Over Voltage Protection**

The converter shuts off to protect itself when the output voltage drawn exceeds 115~140% of its output rating. It must be repowered on to recover.

**LED Indicator**

Equipped with a built-in LED indicator, the converter provides an easy way for users to check its condition through the LED indicator.  
Green : normal operation; No signal: no power or failure.

**Derating Curve**

**a. Single unit operation**

If the unit has no iron plate mounted on its bottom, the maximum ambient temperature for the unit will be 55°C as operating under full load condition. It requires de-rating output current when ambient temperature is between 55~70°C, please refer to the de-rating curve as below.

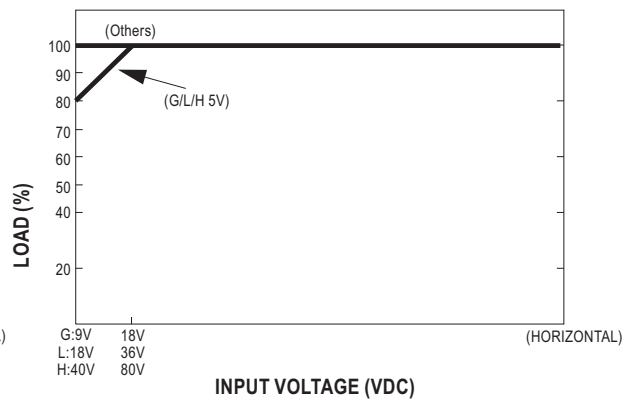
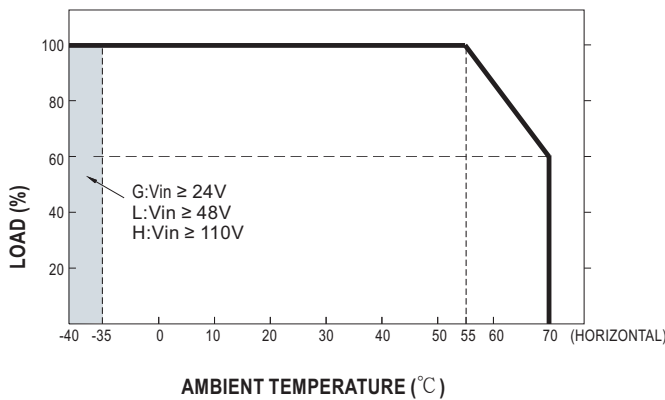

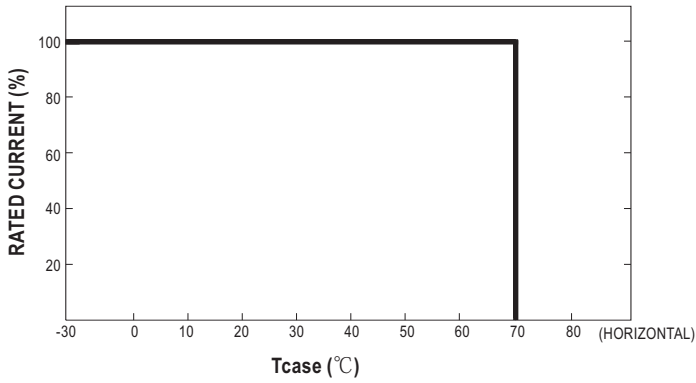

Suitable installation methods are shown as below. Since RSD-60 is a semi-potted model, its thermal performances for the following installation methods are similar and share the same derating curve.

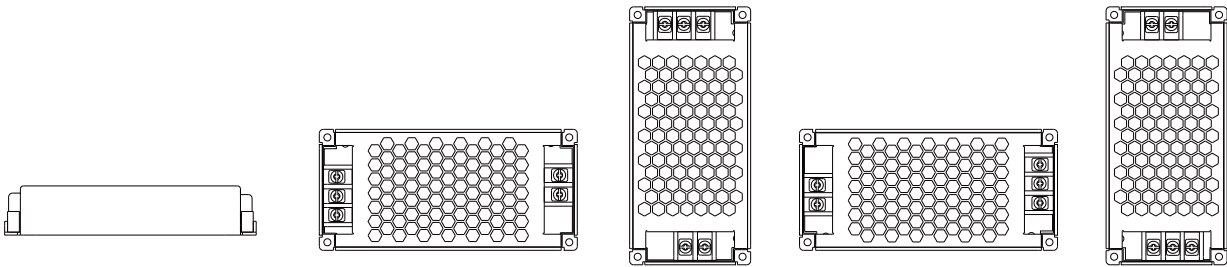

**b. Operate with additional iron plate**

If it is necessary to fulfil the requirements of EN50155 TX level that operate the unit fully-loaded at 70°C, RSD-60 series must be installed onto an iron plate on the bottom. The size of the suggested iron plate is shown as below. In order for optimal thermal performance, the iron plate must have an even & smooth surface and RSD-60 series must be firmly mounted at the center of the iron plate.

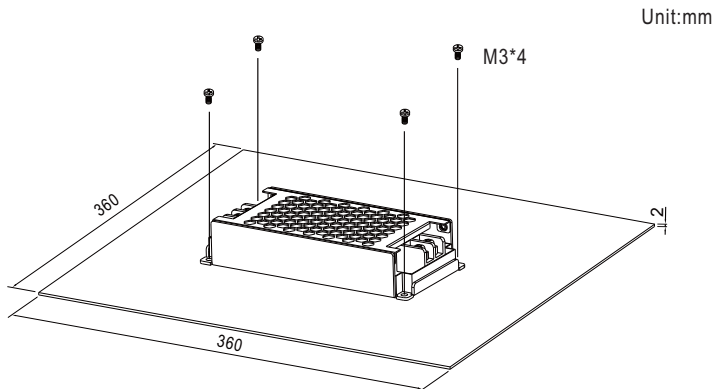

The load vs ambient temperature curve is shown as below.

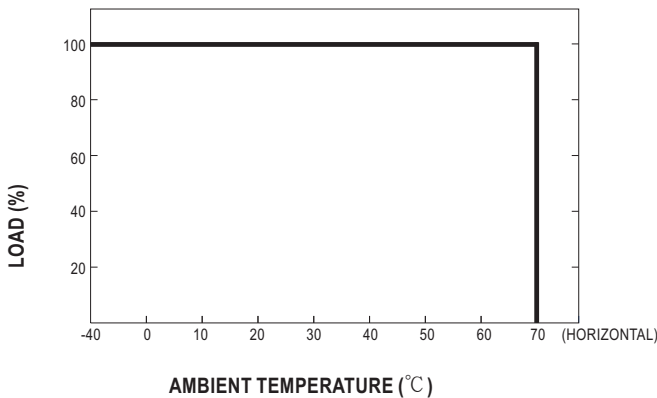

Suitable installation methods are shown as below. Since RSD-60 is a semi-potted model, its thermal performances for the following installation methods are similar and share the same derating curve.

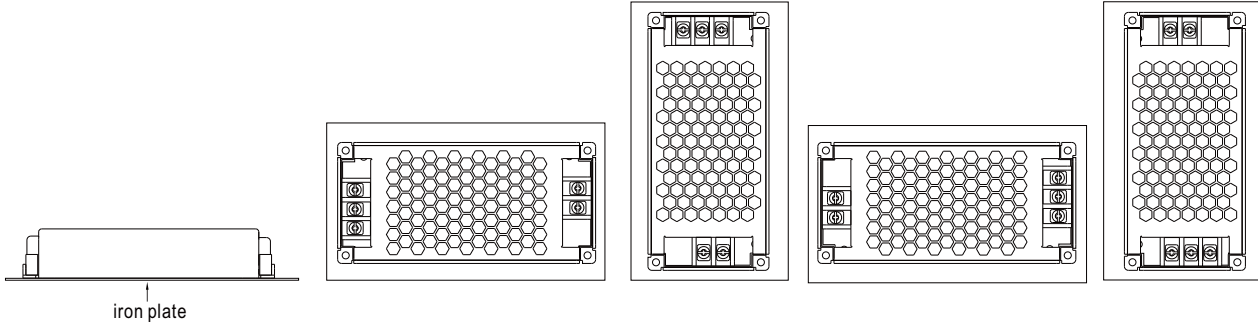

**Immunity to Environmental Conditions**

| Test method                  | Standard                 | Test conditions   | Status |
|------------------------------|--------------------------|---|--------|
| Dry Heat Test                | EN 50155 section 13.4.5  | Temperature: 70°C / 85°C<br>Duration: 6 hrs / 10min                 | PASS   |
| Damp Heat Test, Cyclic       | EN 50155 section 13.4.8  | Temperature: 25°C~55°C<br>Humidity: 90%~100% RH<br>Duration: 48 hrs | PASS   |
| Vibration Test               | EN 50155 section 13.4.10 | Temperature: 19°C<br>Humidity: 65%<br>Duration: 10 mins             | PASS   |
| Shock Test                   | EN 50155 section 13.4.10 | Temperature: 21 ± 3°C<br>Humidity: 65 ± 5%<br>Duration: 30ms*18     | PASS   |
| Low Temperature Storage Test | EN 50155 section 13.4.6  | Temperature: -40°C<br>Dwell Time: 16 hrs                            | PASS   |
| Salt Mist Test               | EN 50155 section 13.4.13 | Temperature: 35°C ± 2°C<br>Duration: 96 hrs                         | PASS   |

**EN45545-2 Fire Test Conditions**

| Test Items       |     |                     |  | Hazard Level |      |      |
|------------------|-----|---------------------|--|--------------|------|------|
| Items            |     | Standard            | HL1                                    | HL2          | HL3  |      |
| PCB              | R22 | Oxygen index test   | EN 45545-2:2020<br>EN ISO 4589-2:2017  | PASS         | PASS | PASS |
|                  |     | Smoke density test  | EN 45545-2:2020<br>EN ISO 5659-2:2017  | PASS         | PASS | PASS |
|                  |     | Smoke toxicity test | EN 45545-2:2020<br>EN 17084:2018       | PASS         | PASS | PASS |
|                  | R24 | Oxygen index test   | EN 45545-2:2020<br>EN ISO 4589-2:2017  | PASS         | PASS | PASS |
|                  | R25 | Glow-wire test      | EN 45545-2:2020<br>EN 60695-2-11:2014  | PASS         | PASS | PASS |
| Potting          | R24 | Oxygen index test   | EN 45545-2:2020<br>EN ISO 4589-2:2017  | PASS         | PASS | PASS |
| Terminals; block | R26 | Vertical flame test | EN 45545-2:2020<br>EN 60695-11-10:2013 | PASS         | PASS | PASS |

**Mechanical Specification**

(Unit: mm , tolerance  $\pm 1$ mm)

Case No.255

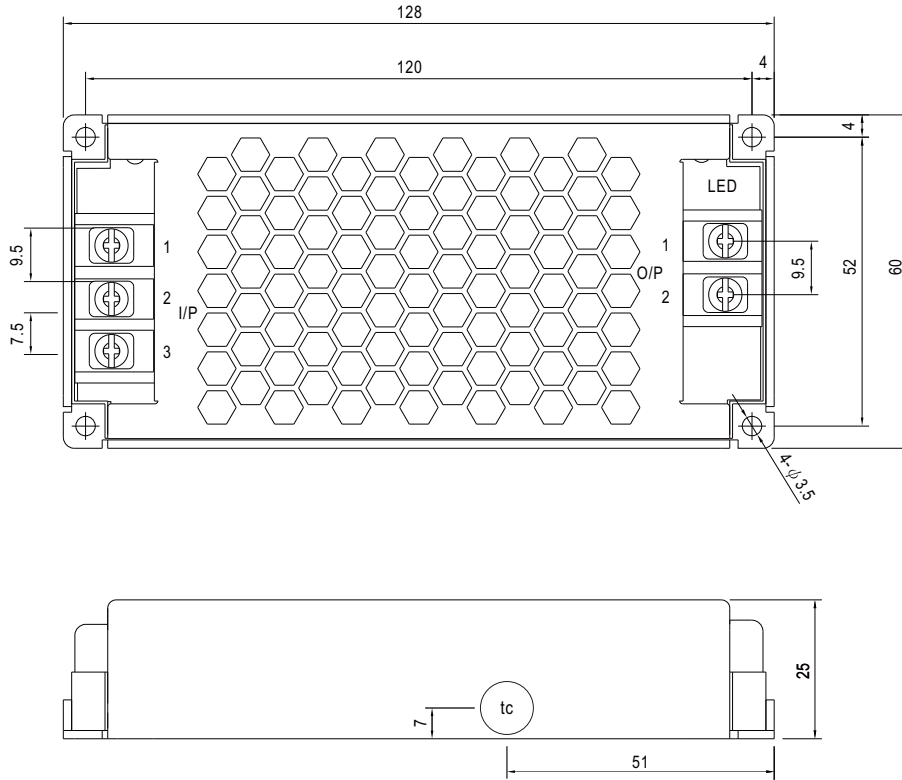

•  $t_c$  : Max. Case Temperature

Input Terminal Pin No. Assignment :

| Pin No. | Assignment  |
|---------|-------------|
| 1       | DC INPUT V+ |
| 2       | DC INPUT V- |
| 3       | FG $\perp$  |

Output Terminal Pin No. Assignment :

| Pin No. | Assignment   |
|---------|--------------|
| 1       | DC OUTPUT -V |
| 2       | DC OUTPUT +V |

**Installation Manual**

Please refer to : <http://www.meanwell.com/manual.html>