



Наличие и актуальные цены на

SDR-120-48

<https://www.mean-well.ru/store/SDR-120-48/>



■ Features :

- High efficiency 91% and low power dissipation
- 150% peak load capability
- Built-in active PFC function, PF>0.93
- Protections: Short circuit / Overload / Over voltage / Over temperature
- Cooling by free air convection
- Can be installed on DIN rail TS-35/7.5 or 15
- UL 508 (industrial control equipment) approved
- BS EN/EN61000-6-2(BS EN/EN50082-2) industrial immunity level
- Built-in DC OK relay contact
- 100% full load burn-in test
- 3 years warranty



■ GTIN CODE

MW Search: <https://www.meanwell.com/serviceGTIN.aspx>



SPECIFICATION

MODEL	SDR-120-12		SDR-120-24		SDR-120-48	
OUTPUT	DC VOLTAGE	12V	24V		48V	
	RATED CURRENT	10A	5A		2.5A	
	CURRENT RANGE	0 ~ 10A	0 ~ 5A		0 ~ 2.5A	
	RATED POWER	120W	120W		120W	
	PEAK CURRENT	15A	7.5A		3.75A	
	PEAK POWER <small>Note.6</small>	180W (3 sec.)				
	RIPPLE & NOISE (max.) <small>Note.2</small>	100mVp-p	100mVp-p		120mVp-p	
	VOLTAGE ADJ. RANGE	12 ~ 14V	24 ~ 28V		48 ~ 55V	
	VOLTAGE TOLERANCE <small>Note.3</small>	± 1.0%	± 1.0%		± 1.0%	
	LINE REGULATION	± 0.5%	± 0.5%		± 0.5%	
	LOAD REGULATION	± 1.0%	± 1.0%		± 1.0%	
	SETUP, RISE TIME	1500ms, 60ms/230VAC 3000ms, 60ms/115VAC at full load				
HOLD UP TIME (Typ.)	20ms/230VAC 20ms/115VAC at full load					
INPUT	VOLTAGE RANGE <small>Note.7</small>	88 ~ 264VAC	124 ~ 370VDC			
	FREQUENCY RANGE	47 ~ 63Hz				
	POWER FACTOR (Typ.)	0.93/230VAC	0.96/115VAC at full load			
	EFFICIENCY (Typ.)	89%	91%		90.5%	
	AC CURRENT (Typ.)	1.4A/115VAC	0.7A/230VAC			
	INRUSH CURRENT (Typ.)	35A/115VAC	70A/230VAC			
LEAKAGE CURRENT	<1mA / 240VAC					
PROTECTION	OVERLOAD	Normally works within 110 ~ 150% rated output power for more than 3 seconds and then shut down o/p voltage >150% rated power, constant current limiting with auto-recovery within 3 seconds and shut down o/p voltage after 3 seconds				
	OVER VOLTAGE	14 ~ 17V	29 ~ 33V		56 ~ 65V	
	OVER TEMPERATURE	95°C ± 5°C (TSW) detect on heatsink of power switch Protection type : Shut down o/p voltage, re-power on to recover				
FUNCTION	DC OK REALY CONTACT RATINGS (max.)	60Vdc/0.3A, 30Vdc/1A, 30Vac/0.5A resistive load				
	WORKING TEMP.	-25 ~ +70°C (Refer to "Derating Curve")				
ENVIRONMENT	WORKING HUMIDITY	20 ~ 95% RH non-condensing				
	STORAGE TEMP., HUMIDITY	-40 ~ +85°C, 10 ~ 95% RH				
	TEMP. COEFFICIENT	± 0.03%/°C (0 ~ 50°C)				
	VIBRATION	Component:10 ~ 500Hz, 2G 10min./1cycle, 60min. each along X, Y, Z axes; Mounting: Compliance to IEC60068-2-6				
SAFETY & EMC (Note 4)	SAFETY STANDARDS	UL508, TUV BS EN/EN62368-1, AS/NZS 62368.1, EAC TP TC 004, BSMI CNS15598-1 approved;(meet BS EN/EN60204-1)				
	WITHSTAND VOLTAGE	I/P-O/P:3KVAC I/P-FG:2KVAC O/P-FG:0.5KVAC O/P-DC OK:0.5KVAC				
	ISOLATION RESISTANCE	I/P-O/P, I/P-FG, O/P-FG:>100M Ohms / 500VDC / 25°C / 70% RH				
	EMC EMISSION	Compliance to BS EN/EN55032 (CISPR32), BS EN/EN61204-3 Class B, BS EN/EN61000-3-2,-3, EAC TP TC 020, CNS15936 Class B				
OTHERS	EMC IMMUNITY	Compliance to BS EN/EN61000-4-2,3,4,5,6,8,11, BS EN/EN55035, BS EN/EN61000-6-2 (BS EN/EN50082-2), BS EN/EN61204-3, heavy industry level, EAC TP TC 020, SEMI F47 approved				
	MTBF	1764.6K hrs min. Telcordia SR-332 (Bellcore) ; 292.1K hrs min. MIL-HDBK-217F (25°C)				
NOTE	DIMENSION	40*125.2*113.5mm (W*H*D)				
	PACKING	0.67Kg; 20pcs/14.4Kg/1.0CUFT				
<p>1. All parameters NOT specially mentioned are measured at 230VAC input, rated load and 25°C of ambient temperature.</p> <p>2. Ripple & noise are measured at 20MHz of bandwidth by using a 12" twisted pair-wire terminated with a 0.1 μ F & 47 μ F parallel capacitor.</p> <p>3. Tolerance : includes set up tolerance, line regulation and load regulation.</p> <p>4. The power supply is considered a component which will be installed into a final equipment. The final equipment must be re-confirmed that it still meets EMC directives. (as available on https://www.meanwell.com/Upload/PDF/EMI_statement_en.pdf)</p> <p>5. Installation clearances : 40mm on top, 20mm on the bottom, 5mm on the left and right side are recommended when loaded permanently with full power. In case the adjacent device is a heat source, 15mm clearance is recommended.</p> <p>6. 3 seconds max., please refer to peak loading curves.</p> <p>7. Derating may be needed under low input voltage. Please check the derating curve for more details.</p> <p>8. The ambient temperature derating of 3.5°C/1000m with fanless models and of 5°C/1000m with fan models for operating altitude higher than 2000m(6500ft).</p> <p>※ Product Liability Disclaimer : For detailed information, please refer to https://www.meanwell.com/serviceDisclaimer.aspx</p>						

Mechanical Specification

(Unit: mm , tolerance ± 1 mm)

Case No.992A

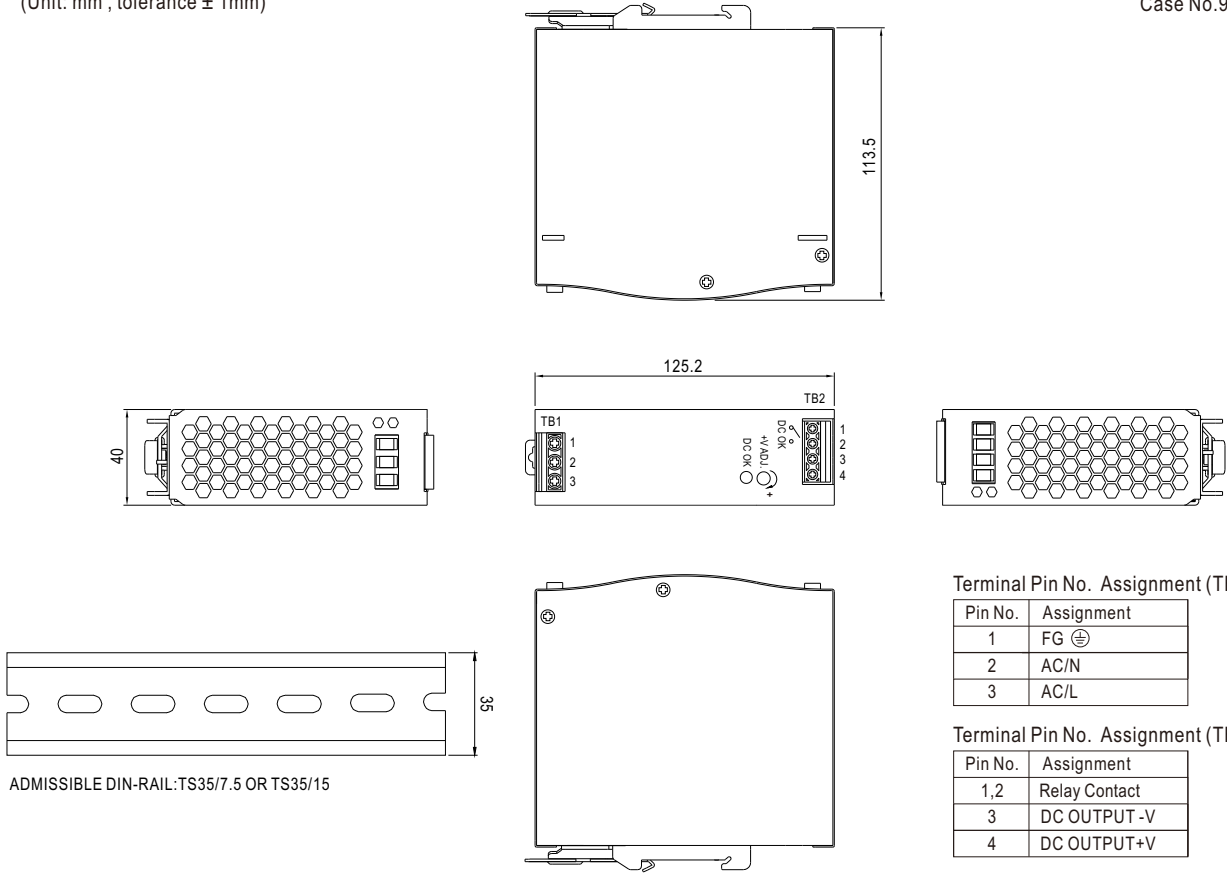

Block Diagram

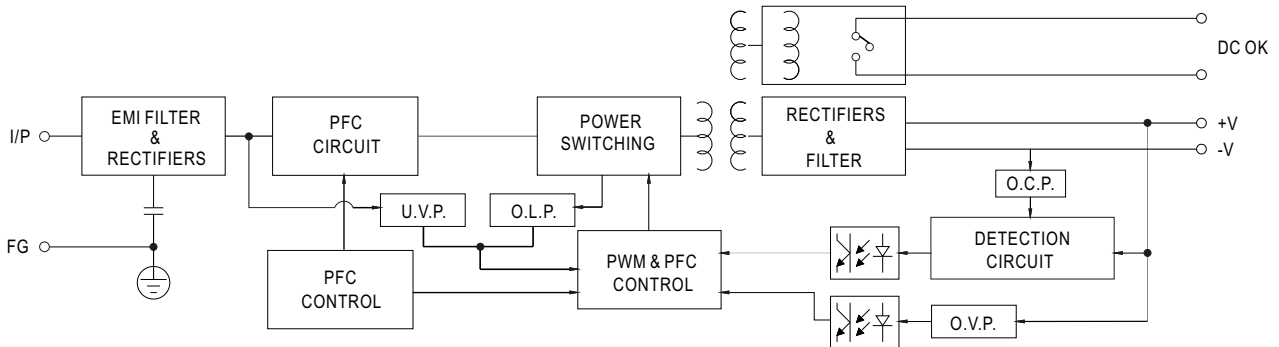

DC OK Relay Contact

Contact Close	PSU turns on / DC OK.
Contact Open	PSU turns off / DC Fail.
Contact Ratings (max.)	30V/1A resistive load.

■ Peak Loading

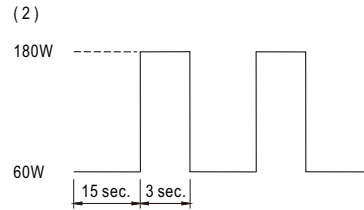
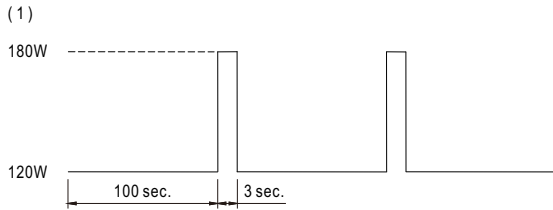

■ Derating Curve

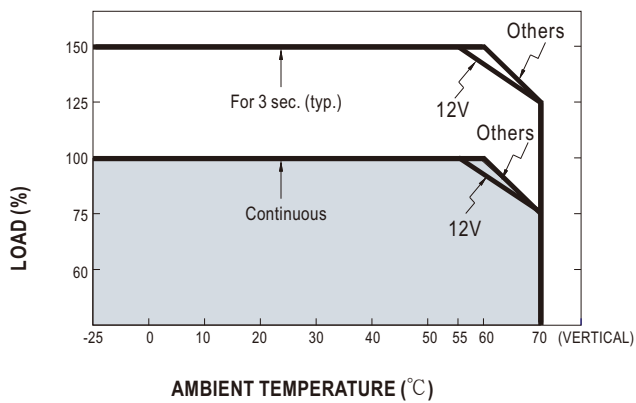

■ Output derating VS input voltage

